

## SSR Integrated Soft starter

### Selection Guide

1. Bypass built-in
2. Multiple protections
3. Space saving
4. Three-phase control
5. Optional communication
6. Easy to control



## SSR Integrated Soft starter

Based on our rich experience in industry application and deep understanding of customers' needs, SSR series soft starter, an overall digital intelligent motor controller and motor protector has been developed. It can control the motor to start and stop at a smoothly changing speed, it also offers the best protection to motor and itself. It is a better control method to replace the traditional  $\Delta$ -Y motor start and auto transformer start controls.

It adopts RS485 communication interface, supporting Modbus protocol. It is suited for industrial bus monitoring and control, and widely used on textile, metallurgy, petroleum, chemical industry, water treatment, shipping, transportation, medicine, food processing, mining and mechanical equipment.

New functions are added to improve the reliability and convenience for customer applications.

# Description & Function

## Functions:

- ◆ Start/stop slope and voltage set by 3 different potentiometer built-in
- ◆ By pass relay built-in, No need for extra contactor
- ◆ Voltage slope start-up mode
- ◆ The output torque can be maintained during the stop process (Continuous torque control) , prevent water hammer effect
- ◆ External $\Delta$ , Y Wiring mode
- ◆ Real-time data of communication(A,B,C phase current, average current) \*1
- ◆ Reading history fault records by communication ( 10 history log)\*1
- ◆ The statistics data can be read by modbus communication.\*1
- ◆ Protections :
  - 1) Overcurrent protection
  - 2) Over load protection with classes 10A, 10, 20 and 30
  - 3) Three phase current imbalance protection
  - 4) No voltage/Missing phase protection
  - 5) Phase sequence protection
  - 6) SCR overheating protection
- ◆ 1 start/stop Digital Input
- ◆ Communication Interface. \*1
- ◆ Option Build In start/stop switch \*2
- ◆ 2 Output relay(running relay, trip relay)

Note \*1: Option, only if select the RS-485 communication interface with the function.

Note \*2: The function is available by using optional SSR switch on operating panel.

## Features:

- ◆ Three-Phase control
- ◆ Optional main voltage 220/400/500 VAC
- ◆ Wide Range Control Voltage 100 - 240VAC, 50/60 Hz
- ◆ Optional Control voltage 24VDC
- ◆ Rated current 1.5-150A
- ◆ Control Board Enhanced Coating
- ◆ Integrate construction, Protection grade IP21.
- ◆ Direct Potentiometer Setting, Easy To Use.
- ◆ All Range Bypass Built in, Easy To Install,
- ◆ Reduce Energy Consumption.  
Optional Modbus RTU for monitoring.
- ◆ Most of communication protocols supported.
- ◆ Motor protections build-in

The controlling circuit boards in the SSR softstarter have a protective coating to ensure a reliable operation even in tough environments like wastewater plants, where corrosive gases and acids may exist.

# Description & Function

## Technical data:

Input Voltage	220/400/500VAC 50/60Hz
Control Source Voltage	100~240VAC or 24VDC 50/60Hz
Current class	1.5.....150A
Initial Voltage	30%~70%
Start Slope	1~30Sec
Stop Slope	0~30Sec
Overload	3 x I <sub>e</sub> for 7 Sec
Times of start per hour	<5, 5-10 (light load or no-load)
Overload grade	10A
Operation Environmental temperature	0 °C to + 50 °C (32 °F to 122 °F)
Store temperature	-40 °C to + 70 °C (-40 °F to 158 °F)
Maximum altitude	1000m (3280ft)
Ingress Protection grade	IP21

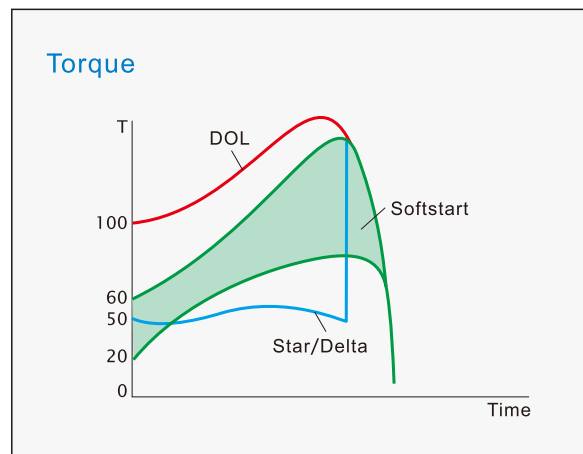
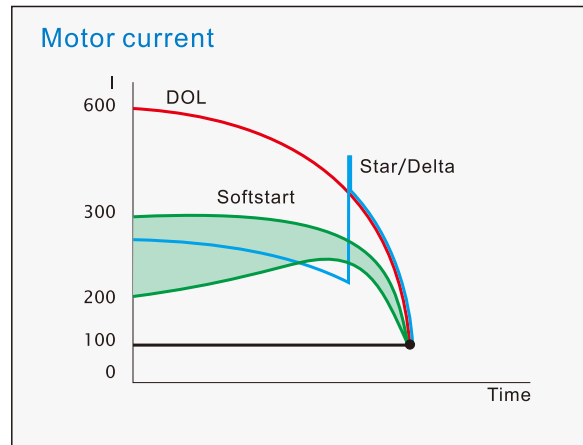
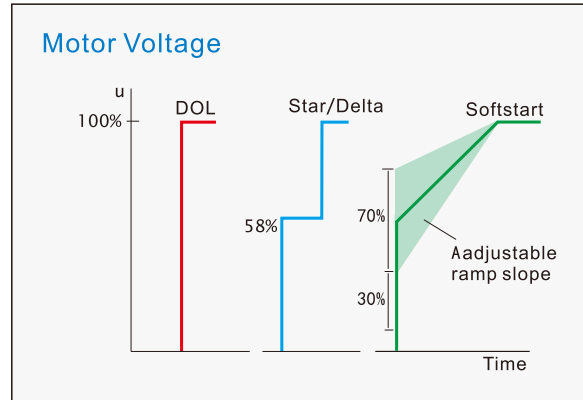

# Product Model

## Model description:

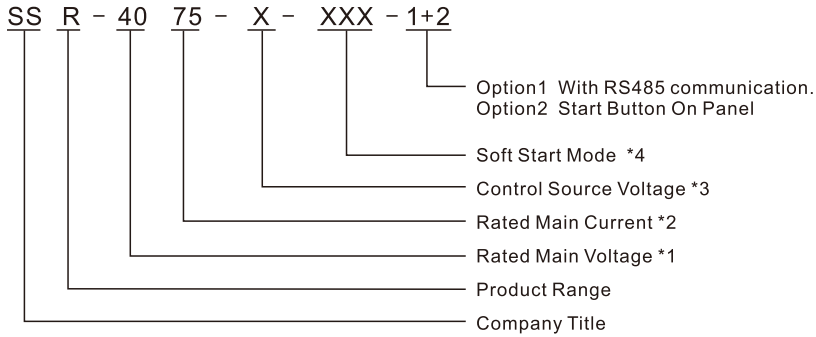

- ※
- 1、Rated Main Voltage 22 : 220V ;  
40 : 400V ; 50 : 500 ;
  - 2、Rated Main Current 1.5-150A ;
  - 3、Control Source Voltage A :  
100-240VAC ; B : 24VDC
  - 4、Soft Start Mode :  
3P3 : Three-phase controlling ;  
1P1 : Single-phase controlling ;

## Internal Control Diagram:

1、3P3( Only Use For Three Phase Motor )

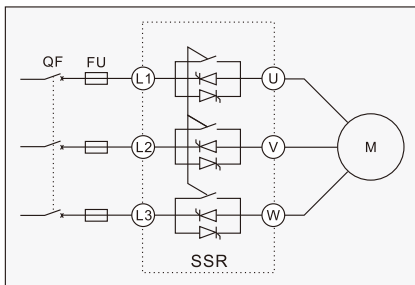

2、1P1( Only Use For Single Phase Motor )

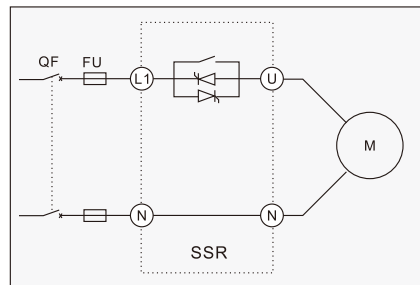

## Soft Starter Wiring Mode :

1、△ External Wiring

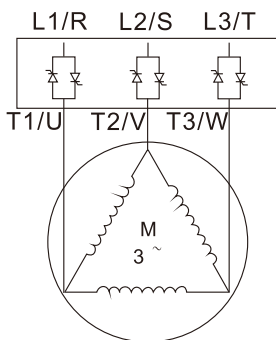

2、Y External Wiring

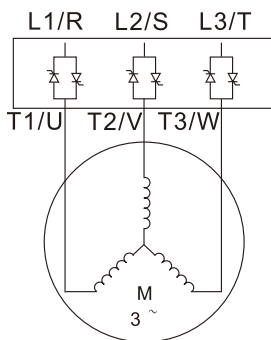

# Product Model

## Rated current

Parameters (Type 3P3)

Model	Rated power of the motor			Rated current I <sub>e</sub> A	Structure F	Weight kg
	220V P <sub>e</sub> /kW	400V P <sub>e</sub> /kW	500V P <sub>e</sub> /kW			
SSRXX 1T5-X-3P3	0.37	0.75	1.1	1.5	A	1
SSRXX 2T2-X-3P3	0.55	1.1	1.5	2.2	A	1
SSRXX 03-X-3P3	0.75	1.5	2.2	3	A	1
SSRXX 4T5-X-3P3	1.1	2.2	3.7	4.5	A	1
SSRXX 7T5-X-3P3	1.5	3.7	5.5	7.5	A	1
SSRXX 11-X-3P3	2.2	5.5	7.5	11	A	1
SSRXX 15-X-3P3	3.7	7.5	11	15	B	1.4
SSRXX 22-X-3P3	5.5	11	15	22	B	1.4
SSRXX 30-X-3P3	7.5	15	18.5	30	C	2.4
SSRXX 37-X-3P3	11	18.5	22	37	C	2.4
SSRXX 45-X-3P3	15	22	30	45	C	2.4
SSRXX 60-X-3P3	18.5	30	37	60	C	2.4
SSRXX 75-X-3P3	22	37	45	75	C	2.4
SSRXX 90-X-3P3	25	45	55	90	D	5
SSRXX 110-X-3P3	30	55	75	110	D	5.2
SSRXX 150-X-3P3	37	75	90	150	D	5.2

※Note: 1、1T5 means 1.5A, 4T5 means 4.5A, 7T5 means 7.5A in Rated current.  
2、Other voltage classes can be made to order.

Parameters (Type 1P1)

Model	Rated power of the motor		Rated current I <sub>e</sub> A	Structure F	Weight kg
	220V P <sub>e</sub> kW	400V P <sub>e</sub> kW			
SSRXX02-X-1P1	0.37	0.55	2	A	1
SSRXX03-X-1P1	0.55	0.75	3	A	1
SSRXX04-X-1P1	0.75	1.1	4	A	1
SSRXX06-X-1P1	1.1	1.5	6	A	1
SSRXX09-X-1P1	1.5	2.2	9	A	1
SSRXX12-X-1P1	2.2	3.7	12	A	1
SSRXX20-X-1P1	3.7	5.5	20	A	2.4
SSRXX30-X-1P1	5.5	7.5	30	C	2.4
SSRXX37-X-1P1	7.5	11	45	C	2.4

## Selection Guide

**Light Load Application:** For example pump, compressor, venting equipment, conveying equipment...select the SSR soft starter based on rated power. (Select the model based on rated current when controlling heating equipment)

**Heavy Load Application:** For example, centrifugal fan, mixer, grinder, blender...Or other equipment started frequently in short time we recommend to choose a higher power grade softstarter.

# Application Diagram

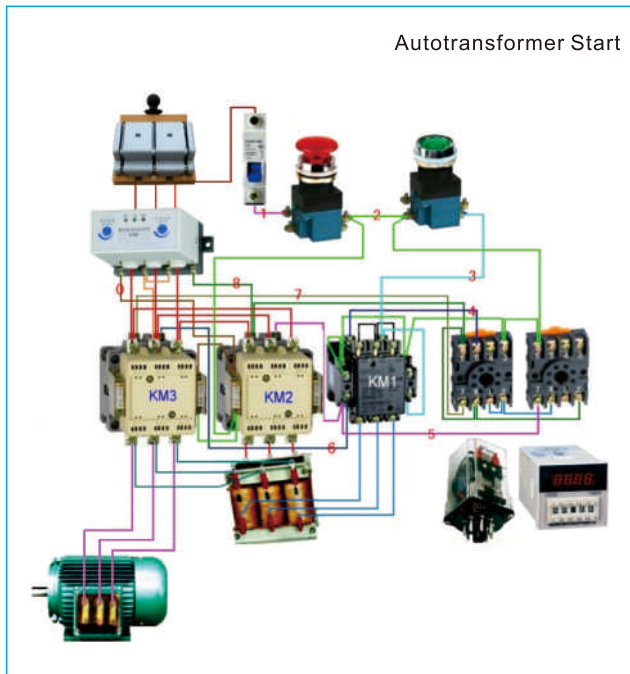
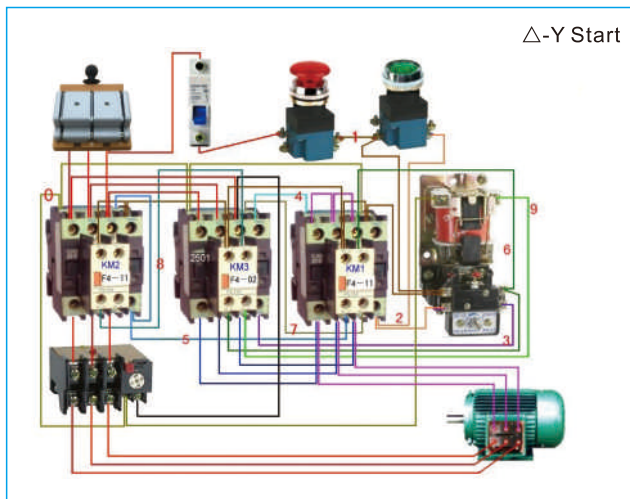

A Perfect Alternative to  $\Delta$ -Y Start And Autotransformer Start

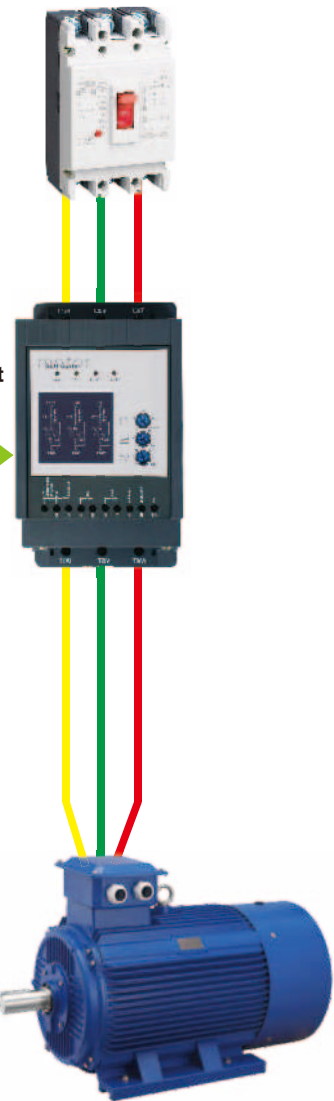

## Reliable

### Perfect motor's protection

SSR Combine the perfect protection function , It can deal with the abnormal state of electric power grid or motor , the powerful adaptability would ensure the stable operation.

## Energy-saving

### The built-in by-pass,

All range Bypass built in, save time, lower consume. when the motor operation at rated speed, the soft starter triggered by pass relay, so it would save the transistor heating and save energy consume. The bypass circuit is strictly screened and tested, help customer save the wiring and installation & check time. Meanwhile it will minimize the cabinet.

## Efficient

### Perfect pump control function

SSR have many special functions to improve efficiency, for example the Continuous torque control for the pump.

## High-quality

### Non-contact start/stop motor control

The start and the stop process of SSR with smooth current change and non surge close and non arcing break. Greatly prolongs the service life of the equipment.

# Technical data

General	
Frequency	50/60Hz±5Hz
Rated Main Voltage	220-500±10% VAC (chosed by customer); 400VAC±10%(acquiescent)
Control Source Voltage	100-240VAC-15%+10% or 24VDC(chosed by customer); 100-240VAC±10%(acquiescent)
The motor adapted	Three-phase squirrel-cage induction motor
Times of start per hour	<5 at 400% FLA
Operating data	
Motor rated operational current	Motor full load current: 1.5-150A
Initial voltage	30%~70%Un
Start Slope	1-30 seconds
Stop Slope	0-30 seconds
Motor protections	
Over current	During start , operation , stop , output current over limit
Unbalanced Current	Output current unbalanced level beyond the setting
I <sup>2</sup> t over load	May set to 10A,10...overload protection base on the setting to delay protection stop
Missing phase/No voltage	Stop the softstarter when 1 or 2 phases failed Or no voltage input
Thyristor(SCR) overtemp	Stop the softstarter when the radiator temperature rises above 80°C
Phase sequence	Forbid starting when the input phase sequence is wrong ( If the function is unnecessary, please tell us before ordering)

## Rapid fuse

Model	SCR <sup>2</sup> T(A <sup>2</sup> S)	Fuse rating
SSRXX 1T5-X-3P3	70	5A
SSRXX 2T2-X-3P3	150	10A
SSRXX 03-X-3P3	270	10A
SSRXX 4T5-X-3P3	610	16A
SSRXX 7T5-X-3P3	1700	25A
SSRXX 11-X-3P3	3630	32A
SSRXX 15-X-3P3	5000	40A
SSRXX 22-X-3P3	7500	50A
SSRXX 30-X-3P3	10000	63A
SSRXX 37-X-3P3	11000	100A
SSRXX 45-X-3P3	12000	160A
SSRXX 60-X-3P3	15000	200A
SSRXX 75-X-3P3	18000	250A
SSRXX 90-X-3P3	40000	315A
SSRXX 110-X-3P3	60000	315A
SSRXX 150-X-3P3	100000	400A



# Dimensions

SSR softstarters:

SSR1.5~11A  
Model A

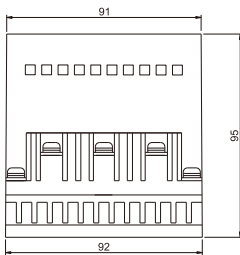

SSR15~22A  
Model B

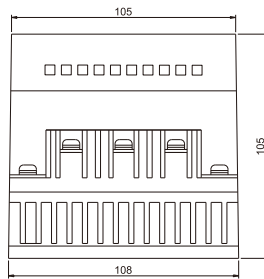

SSR30~75A  
Model C

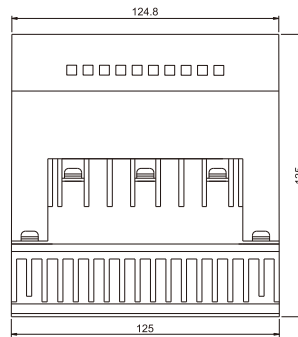

SSR90~150A  
Model D

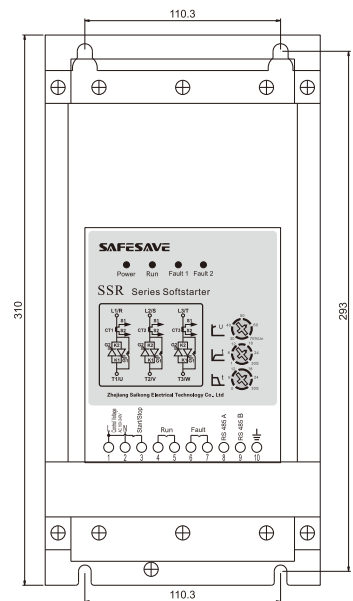
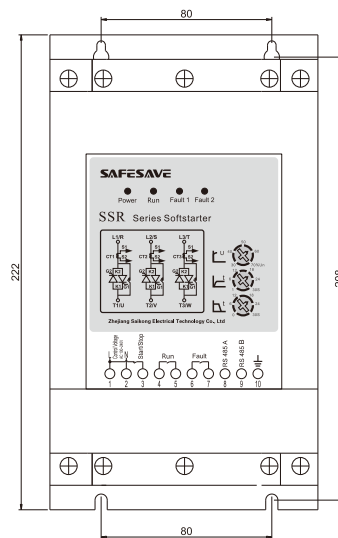
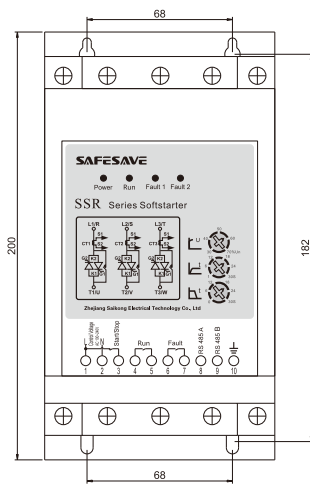
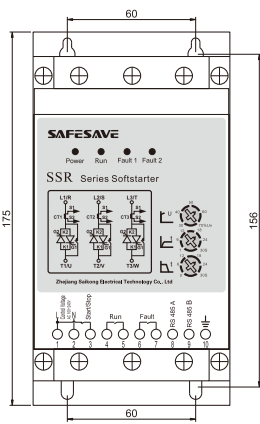
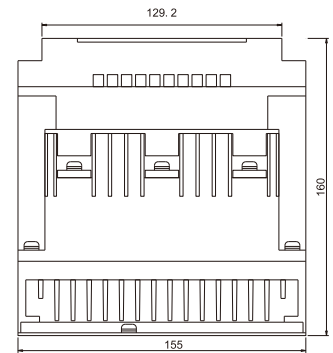





**By Industry**  
**Fan**  
**Blender**  
**Pump**  
**Crusher**  
**Compressor**  
**Conveyor belt**  
**Pulping machine**  
**Etc.**

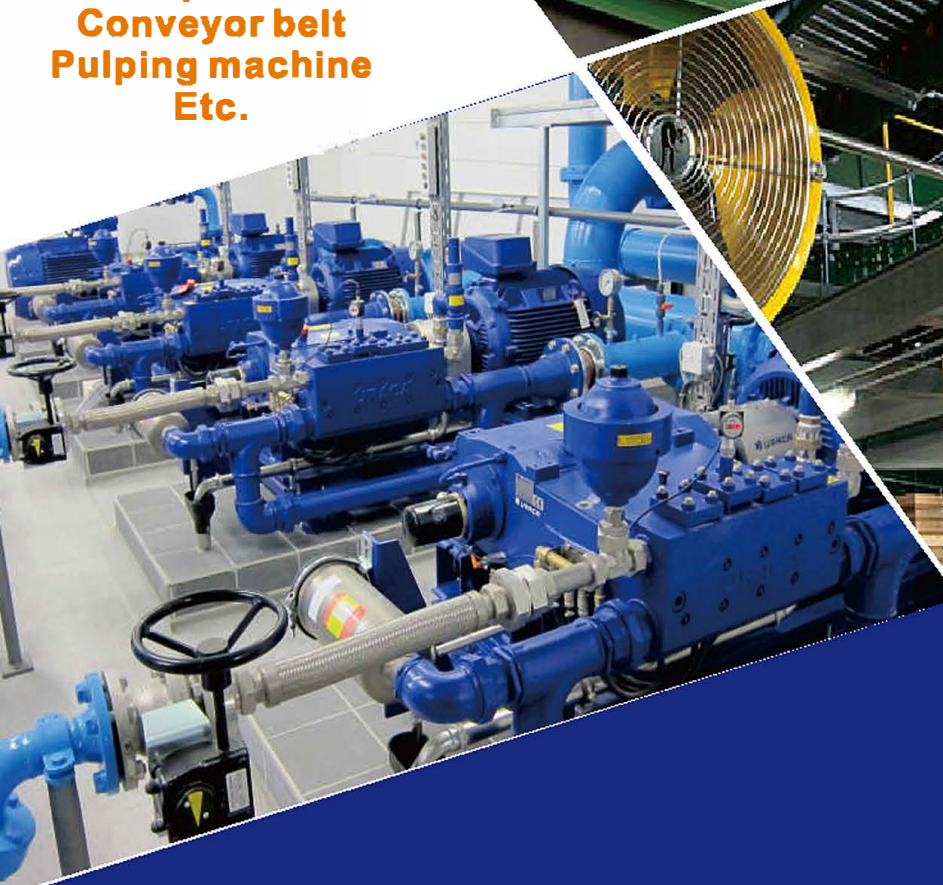

**SAFESAVE**

Zhejiang Saikong Electrical Technology Co., Ltd

Nationwide hotline: +86 0577 61768877

Address: #22 Liujiang Avenue, Liushi Town, Yueqing City,  
Zhejiang Province, China

Website: [www.safeinvert.com](http://www.safeinvert.com)

Skype/Whatsapp/Wechat: +86-13373857120



WEBSITE



WECHAT