

AC310-Series High-performance Vector AC Drive

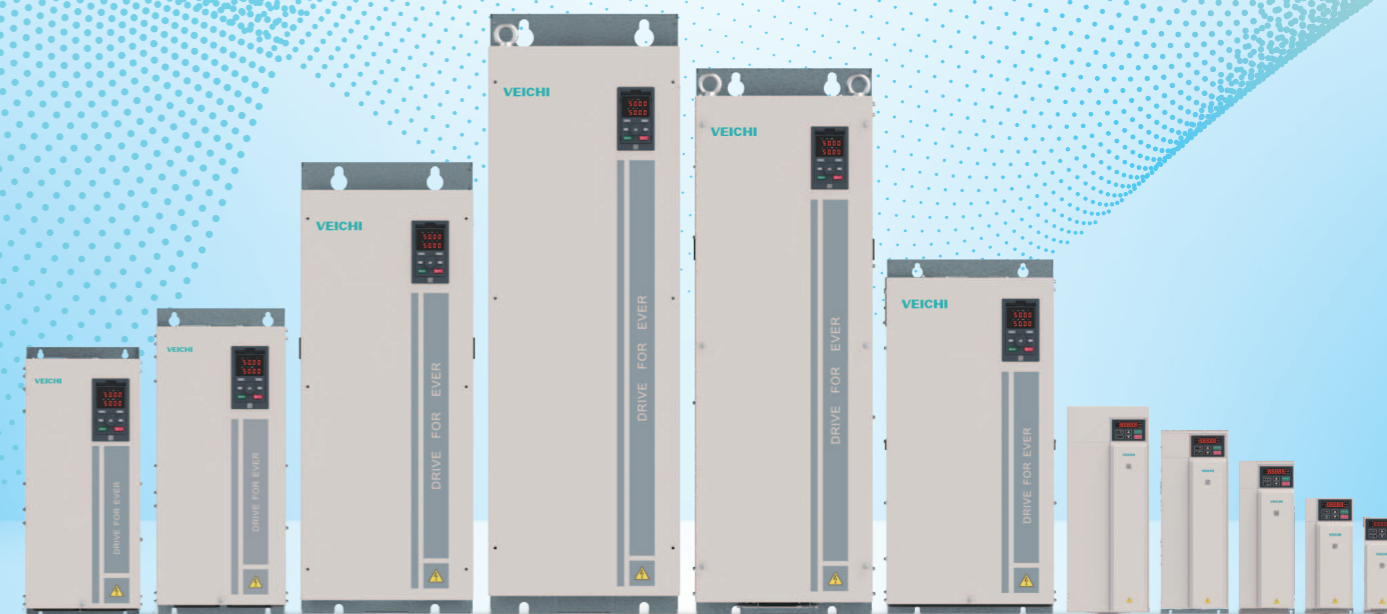

VEICHI

Suzhou Veichi Electric Co., Ltd

No.1000 Songjia Road, Guoxiang street, Wuzhong Economic and Technological Development Zone, Suzhou

Tel: +86-512-6617 1988 Fax: +86-512-6617 3610

Facebook: <https://www.facebook.com/veichigroup>

Whatsapp: +86- 138 2881 8903

<https://www.veichi.org/>



Official Website
*Version:May. 2023
Veichi Electric Co., Ltd all rights reserved,
subject to change without notice.

About us



Veichi (stock code: 688698) has always committed to electric drive and industrial control since its foundation. As an all-round company engaged in R & D, manufacturing and sales on high-tech industrial automation products, Veichi has been identified with several honorary titles such as the third patch of Specialized and Sophisticated Enterprises That Produce New and Unique Products, New and High-tech Enterprise, Jiangsu Engineering Technology Research Center, Jiangsu Provincial-level Enterprise Technology Center, Jiangsu Private-own Technical Enterprise, and has obtained the highest level of enterprise credit. Through years of independent research and development, Veichi now has been authorized with patents totaling 163 by the end of June, 2023, and among them 43 are for invention.

Having established R & D center and manufacturing bases in Suzhou, Shenzhen and Xi'an, added with the wholly-owned subsidiary in India, Veichi now are dealing with customers from several nations and regions and has the full capability to provide safe, competitive and trustworthy products and services to customers from the larger world.

Veichi provides various products including AC drive, servo

system, and control system, which are applied in all sorts of fields like heavy industry, mining, petroleum and petrochemical, machine tools, hydraulic transmission, photovoltaic pumping, high-efficiency energy, robotics, printing and packaging, textile, new energy, medical and many other industries

20 service stations and 211 contracted distributors cover 31 provinces on China mainland and Hong Kong, Macao and Taiwan regions, which guarantees a massive and efficient network for sales and services for our customers.

Veichi will continue to abide by the operation philosophy, that is, guided by market demand and driven by technological innovation, enlarge and enhance its core business like AC drive, servo system, control system and SIOs. And Veichi will always be devoted to providing quality products and services for customers and further make contributions to the development of electric drive and industrial control.

AC310 series high-performance AC drive

The AC310-series high-performance vector AC drives further extend its advantages on functions and properties based on the design concept of AC300-series hardware architecture and new features of the latest generation of Veichi products. Combined with the world-leading magnetic field-oriented vector control technology and compatibility of both asynchronous and synchronous motor control, this drive supports multiple control methods such as voltage-frequency separation EPS. On promised high performance and high reliability of the product, the layout of components is improved within the unchanged book-like narrow housing for higher usability and industry specialization to reduce choice phobia for customers. Multiple extension ports and accessories are designed to realize high performance, high reliability, high power density and high applicability.



Simple outside while fine inside

Industry-leading vector technology.
Simultaneous synchronous/asynchronous drive.
Integration of multi-industry applications and optimized selection.

Simplify the complexity

Simple wiring & European-style terminals to reduce wiring time and cost.
Simple use by common parameter layout and optimize keys on the panel.
Simple debugging via special upper software to minimize time and difficulty.

A "book" among drives

Book-like design with narrow housing, volume reduced by up to 60% .
Up and down straight-through heat dissipation enabling side-by-side installation of several drives and thus reducing the volume of the electrical cabinet.



2005

- Beginning of entrepreneurship in Shenzhen
- First-generation of AC drive successfully launched

2014

- First stage of Suzhou Veichi project groundbreaking and put into construction

2016

- First stage of Suzhou Veichi project put into operation
- First generation of motion control system launched

2013

- Suzhou Veichi Electric Co., Ltd established
- First generation of servo system successfully developed

2019

- Indian subsidiary established
- Restructure to a company limited by shares

2020

- A-share of science and technology innovation board landing
- Awarded as provincial Specialized and Sophisticated "Small Giant" Firms That Produce New and Unique Products

2021

- A Veichi controlled subsidiary established
- Awarded as the third patch of Specialized and Sophisticated "Small Giant" Firms That Produce New and Unique Products

2022

- Xi'an R&D Center established
- Veichi Digital Energy subsidiary established

2023

- Suzhou Veichi Phase II project put into operation
- Suzhou Veichi Phase III Project put into construction
- Veichi Medical Equipment subsidiary established

Product Features

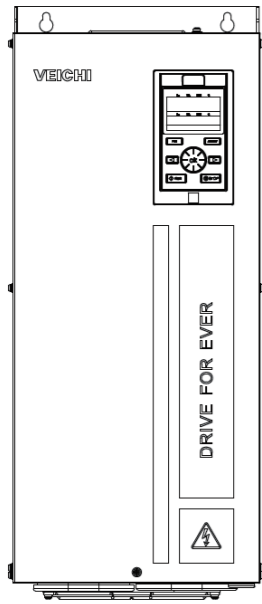

Features overview

- 01 High-performance vector universal platform, new motor control algorithm
- 02 Synchronous and asynchronous drive integrated, open loop and closed loop supported
- 03 Precise torque excitation decoupling, excellent dynamic response performance
- 04 Booklet design for full series to minimize installation space
- 05 Safe and reliable new air duct design of DC fan cooling for full series
- 06 Comprehensive thermal simulation for rational hardware layout
- 07 Innovative grounding method for AC310 series to quickly solve electromagnetic interference
- 08 Modular design of software and hardware for powerful extension capability
- 09 Overall three-proofings for the product and tri-proof paint on PCBA for stable and reliable operation
- 10 Comprehensive expansion ports and accessories for all sorts of applications
- 11 Optimized keyboard design for the new external keyboard
- 12 Simpler on-site debugging methods for field firmware upgrade

General specification

Power level	Single phase 220V 50/60Hz	0.75kW-15kW
	Three phase 220V 50/60Hz	0.75kW-220kW
	Three phase 380V 50/60Hz	0.75kW-1120kW
	Three phase 660V 50/60Hz	22kW-1120kW
Input	Allowable voltage fluctuation	T/S2: -10%~10%; T3: -15%~10%; T6: -10%~10%; Voltage imbalance rate<3%
	Allowable frequency fluctuation	Frequency: ±5%
	Distortion rate	IEC61800-2
Output	Output voltage	0~Input voltage, deviation lower than 5%
	Output frequency range	0-600Hz
	Overload capacity	T/S2: 150% rated current 24s, 180% rated current 3.4s
		T3: 150% rated current 89s, 180% rated current 10s, 200% rated current 3s T6: 150% rated current 89s, 180% rated current 10s, 200% rated current 3s

Performance features

Support multiple types of motors/loads

AC310 series AC drives are capable to drive ordinary three-phase asynchronous motors, variable frequency motors, AC servo motors, permanent magnet synchronous motors, high-speed synchronous motors, spindle motors, torque motors, linear motors, etc to meet the diverse needs from customers.



Control mode selection

Control mode	Speed control	Torque control	Position control	Applicable motor
VF mode	●			Asynchronous motor
Voltage frequency separation	●			Torque motor, EPS power supply, series resonance
High performance vector without PG	●	●		Asynchronous, permanent magnet synchronous
High performance vector with PG	●	●	●	Asynchronous, permanent magnet synchronous, synchronous reluctance

Excellent control performance

Control mode	Speed control range	Starting torque	Applicable motor
High performance vector without PG	1:200	150%	Permanent magnet synchronous motor
High performance vector without PG	1:100	150%	Asynchronous motor
High performance vector with PG	1:1000	200%	Asynchronous, permanent magnet synchronous motor

Standard device for special use, rich functions in one

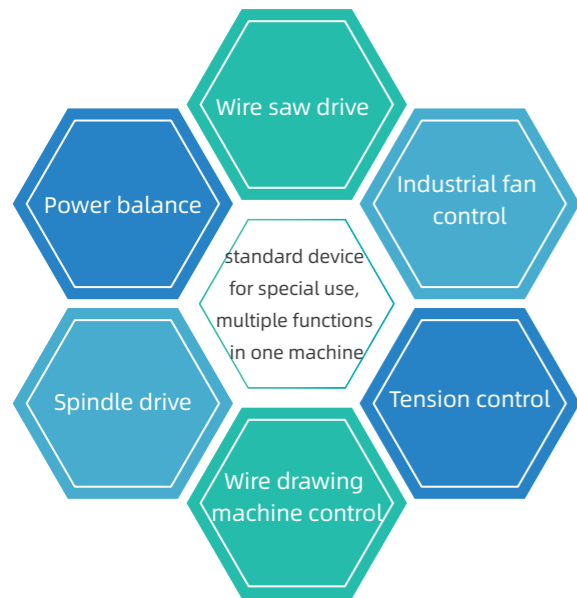

Voltage frequency separation, professional drive

The comprehensive and abundant dedicated function algorithms for voltage-frequency separation can effectively drive torque motors and realize steady-state control of EPS. At the same time, it is widely used in a variety of high-voltage insulation test equipments in power industry.



High starting torque characteristics

Low frequency torque is large. In the closed-loop vector mode, 200% rated torque can be output at 0.0Hz, and it can run stably with load at ultra-low speed of 0.01Hz. Powerful low-torque output can effectively ensure the stability and smooth start-up.

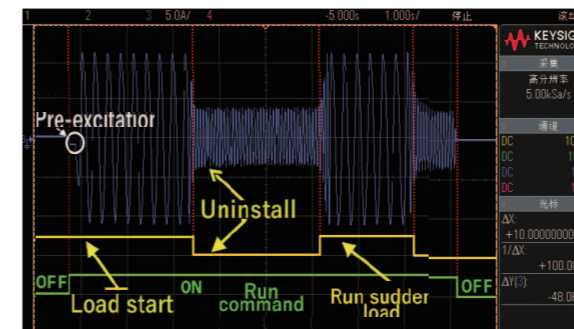

Torque output is stable under torque control mode. The linearity deviation no larger than 3% greatly guarantees the stable operation of the equipment.

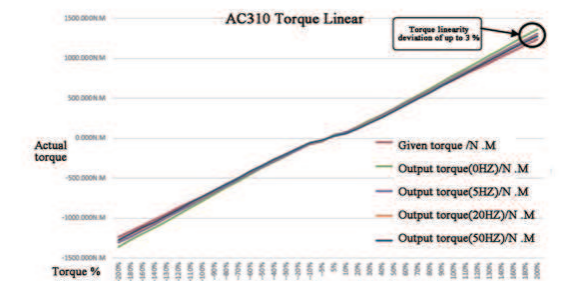

Active response to industry 4.0

With the continuous reform of intelligent production, centralized product control is more common. AC310 products can communicate with different types of DCS systems and PLC systems, and support multiple types of direct communication with HMI. MODBUS-RTU communication is standard while PROFIBUS-DP, CANOPEN and PROFINET are optional.



Software suppression function

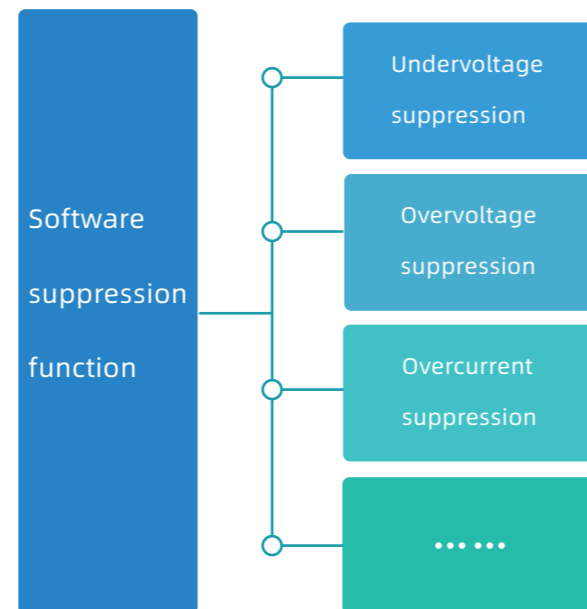

Motor parameter self-tuning

Parameters can still be accurately obtained by self-tuning no matter the motor is rotating or remains idle. Debugging is convenient and simple to maintain higher control accuracy and response speed.

- Rotary self-tuning**: The load must be disconnected for tuning, and it is suitable for occasions with high control accuracy requirements.
- Static self-tuning**: The powerful motor self-tuning algorithm can obtain the motor parameters when the motor is stationary, and the effect is comparable to rotating self-tuning.

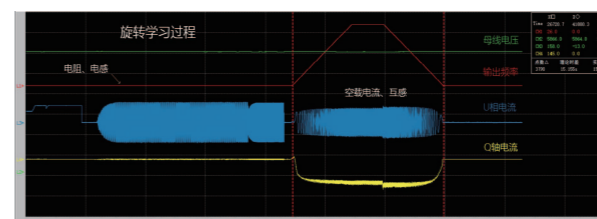

Rotary self-tuning

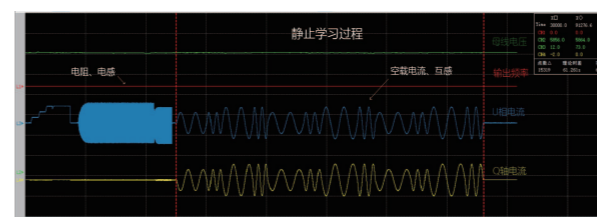

Static self-tuning

Overexcitation braking function

In the case of partial inertia stop, quick braking can be achieved by overexcitation without any additional resistor, which greatly enhances user experience of the product. Moreover, the over-excitation braking function effectively suppresses busbar voltage rise when decelerating to avoid the over-voltage fault, and at the same time realizes fast braking to meet the requirements of quick stop during power failure.

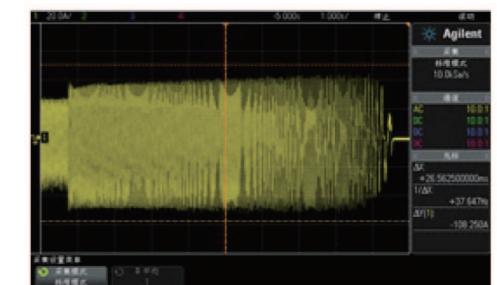

Overexcitation braking function is invalid

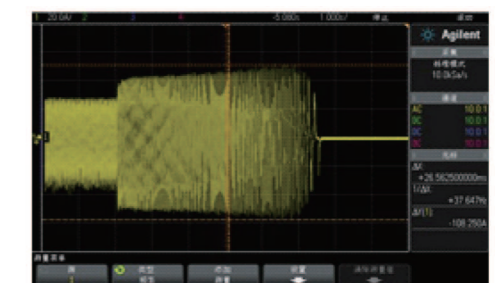

Overexcitation braking function is effective

Stable high-speed weak magnetic control

New weak magnetic control algorithm plus high bandwidth current vector control algorithm ensures stable high-speed weak magnetic running and highly precise weak magnetic output twelve-fold at most.

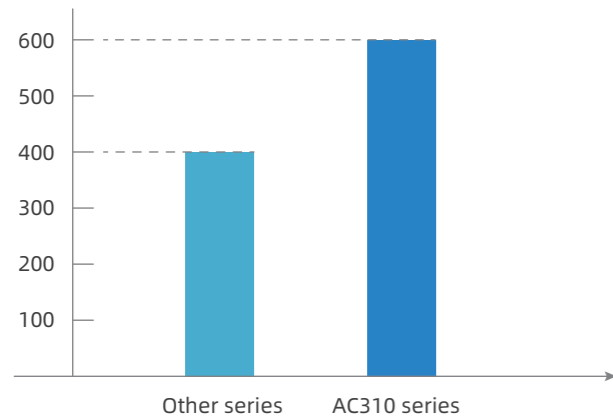

- Other series: The maximum output frequency under vector control is 320/400Hz;
- AC 310 series: The maximum output frequency under vector control is 600Hz.

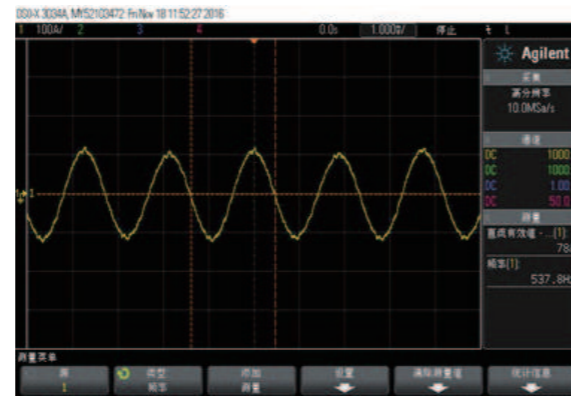

current waveform under 12-fold weak magnetic field

High energy saving

The use of a new generation of energy-saving control technology can realize the efficient operation of induction motors. It can reduce the excitation current according to the load and can also reduce motor and energy loss to the full extent.

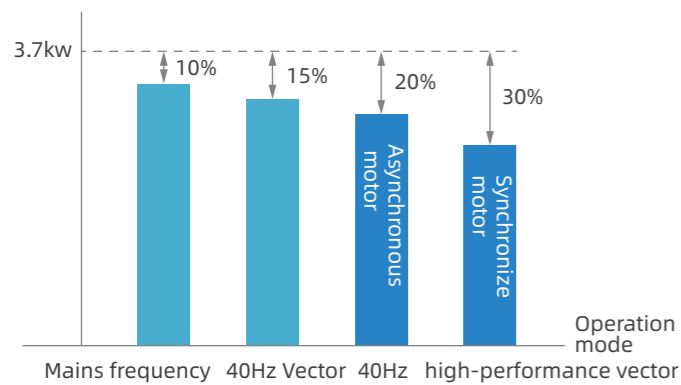

Fan energy saving comparison chart

Other software functions

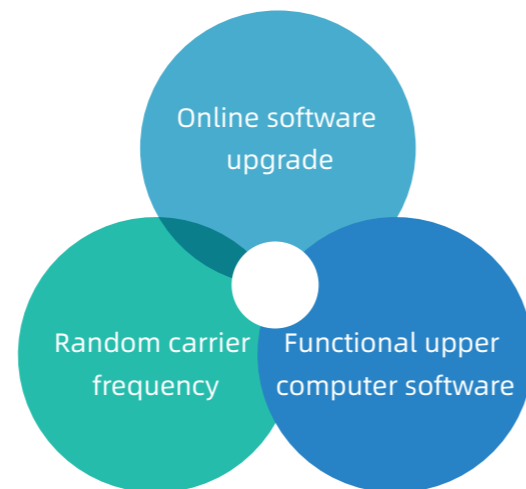

Structural Hardware Characteristics

Concise internal layout and convenient wiring

The narrow-body housing for AC310 series is designed with strict dimensions but still, contains most of the common applications, various expansion interfaces and terminals which are distributed in an orderly manner for easy wiring.

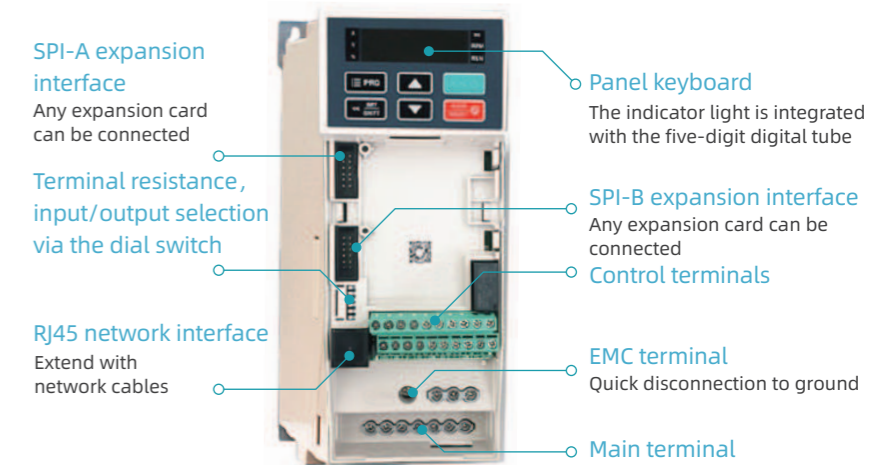

New structure design

Electronic devices are separated from the radiator air duct while capacitors, MOS tubes, relays are designed with stronger protection and both sides of the machine are sealed to raise environmental resistance.

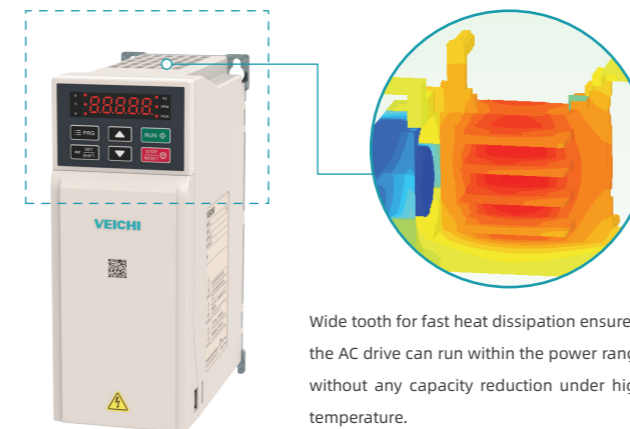

Wide tooth for fast heat dissipation ensures the AC drive can run within the power range without any capacity reduction under high temperature.

Number of standard terminals

Serial number	Unit circuit	Quantity	Remarks
1	Normal X input	5	Bidirectional input
2	Normal Y output	1	Open collector output
3	Relay output	1	Normally open/ normally closed
4	10V power output	1	50mA
	24V power output	1	100mA
5	Voltage/current analog input	2	V/A support free switching
6	Analog output (optional)	1	0-10V
			0-20mA
			0-100kHz pulse output
7	RS485	1	ModBus-RTU
8	Low speed pulse input	1	X5 0-5kHz pulse input

New book-like housing

AC310 whole series drives are designed with narrow bodies like a book, and the volume is 60% smaller than the original one, thus so called "book machine" among drives.



Optimized structure design

Book-like housing plus reasonable use of space greatly saves the main cabinet space and cost for customers.

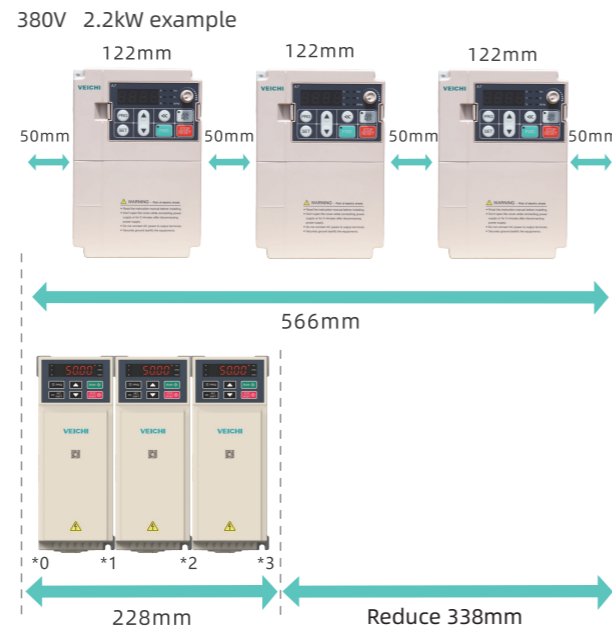

Braking unit and reactor configuration

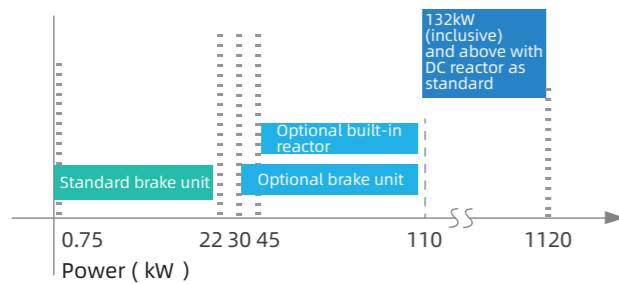

- 0.75~22kW with standard brake unit
 - 30~110kW with optional built-in brake unit
 - 45kW~110kW with optional built-in DC reactor
 - 132kW (inclusive) and above with standard DC reactor
- 630-710kW with standard input reactor

Port characteristics selection via DIP switch

Customers can quickly select the input and output port characteristics via the DIP switch with a screwdriver.

Dialing diagram	Tag	Select location	Function description
RS485 OFF	RS485	485 terminal resistance	RS485 communication access to 120 ohm terminal resistance
AO-F OFF	AO-F	AO output frequency	AO interface 0.0~100kHz frequency output
AO-I OFF	AO-I	AO output current	AO interface 0~20mA current output or 4~20mA current output
AO-U OFF	AO-U	AO output voltage	0~10V voltage output
AI1 U	AI1	AI1 input-current/voltage	AI1 input 0~20mA or 4~20mA or AI1 input 0~10V
AI2 U	AI2	AI2 input-current/voltage	AI2 input 0~20mA or 4~20mA or AI2 input 0~10V

Keyboard operation

This newly designed panel keyboard is easy to use. Built-in keyboard and external keyboard can both display dual rows of data (select built-in or external keyboard by setting related parameters)

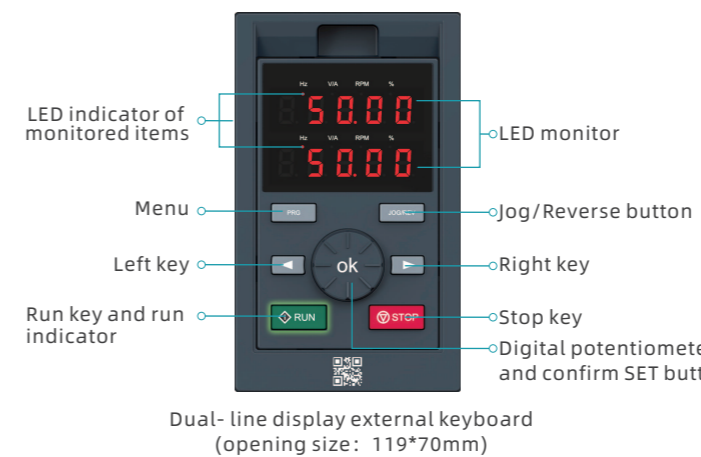
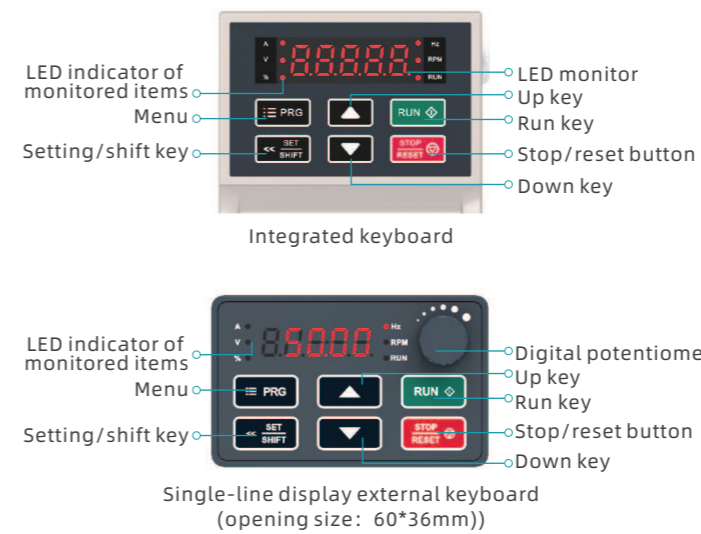

Note: Plastic case below 37KW adopts integrated keyboard, and steel case above 37KW adopts dual line keyboard.

Name	Status	Meaning	
Unit indicator	Hz	Flashing/on	Frequency unit
	A	on	Current unit
	V	Flashing/on	Voltage unit
	RPM	on	Speed unit
	%	Flashing/on	Percentage unit
Status Indicator	RUN	on	Forward running
	RUN	Flashing	Reverse running
	RUN	off	Stop

Fast disassembly and assembly design of the fan

The innovative design of the fan structure on AC310-series ensures the stability and efficiency of the fan and it can be quickly replaced and cleaned without any external tools.

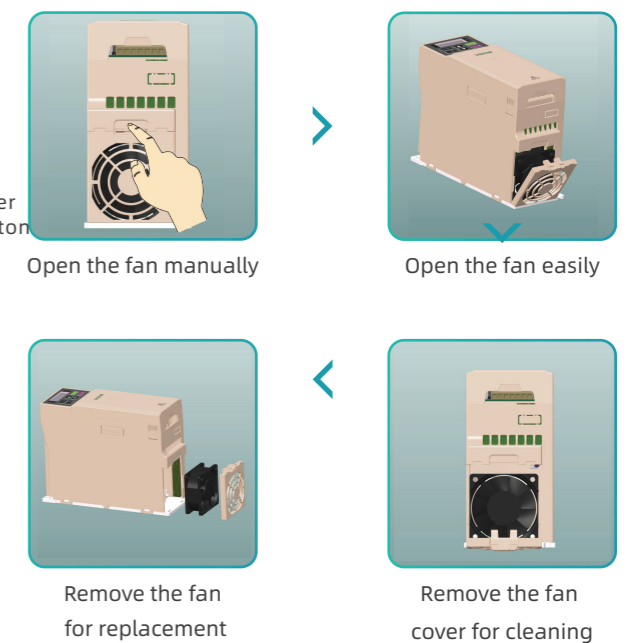

Wide voltage design

Allowable fluctuation of input voltage within ±15% of the standard rated voltage, so it can be protected from voltage fluctuations to apply to demanding grid environment.

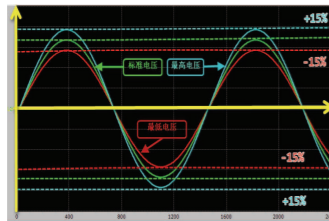

European-style terminals

Standard European-style terminals that meet IEC 60998-2-1; UL 1059; UL 486E specification requirements can ensure safety and reliability and at the same time save wiring time: strip wire → set wire number → lock screws. European-style terminals are used for main circuits on low-power AC310 drives. European-style terminals to the main circuit during wiring can save at least half of the time cost by other terminals thus greatly improve assembly efficiency for customers.

Stripping → setting wire number → crimping cable lugs- screw locking

Stripping → Setting wire No. → Screw locking



Old-fashioned terminal block

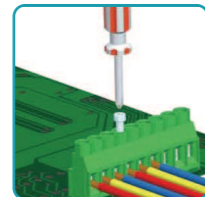

European terminal

	AC310 model	Wire diameter (mm)	Wire cross-sectional area S (mm ²)	Stripping length L (mm)
Main circuit terminal	0.75kW-2.2kW	0.25-2.5	0.05-5.2	7-8
	4.0kW-5kW	0.5-2.5	0.2-5.2	6-7
	7.5kW-11kW	0.8-4	0.5-13	10-11
Wire stripping diagram				

EMC function

EMC allows quick connection or disconnection to ground through terminals to effectively avoid EMC interference.



EMC grounding

Protection function

All-round protection for the internal and peripheral equipment of the AC drive is achieved by output grounding short circuit protection, internal buffer relay protection, fan drive circuit protection, external 24V DC short circuit protection, motor overload protection and other hardware protection functions.

System abnormality	Input phase loss	Stall protection	Accelerating overcurrent	Output phase lost
Load protection 1	Accelerating over-voltage	Fault type	Overheat	PID feedback malfunction
Running under-voltage	Current detection fault		Excessive speed deviation	Motor overload

New motor grounding short-circuit detection

Short-circuit to ground monitoring is on once the motor is on power, and protection will be activated immediately once short circuit is detected and the drive will be forbidden to start.

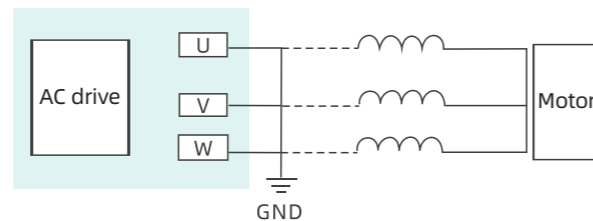

Expandability

Superb expansion capability

Multiple expansion interfaces are designed to meet customized needs.

There are two SPI high-speed interfaces on the AC310 control boards, and the control boards will automatically identify the expansion cards and their parameter groups.

Expansion Card

Expansion card model	Note
IO Expansion Card	Optional, high-speed pulse, relay
RT card	optional, default software tracking
PG	Optional, multi-type encoder
RT card	Optional
Simple logic board expansion card	Optional
GPRS Card	Optional

IO Expansion Card

Attribute	Terminal	Description
Input IO	X6/X7/X8/X10	PLC/COM
High-speed pulse input	X10	0-100KHz
Digital output	Expansion terminal Y2	DC24V/50mA
Relay output	Expansion relay TA2/TB2/TC2	3A/240VAC
Temperature detection	PK+/PK-	Support PT100/PT1000/KTY84, Motor temperature detection
Common port	COM/PLC2	External common port
Switch	S7	External common port

Logic board expansion

The AC drive replaces the PLC to perform simple logic control. Program development environment of the widely used MELSEC programmable controller is used here, while common and comprehensive function blocks are also integrated here.



Veichi IOT

Intelligent modules with high positioning accuracy, are easy to install. GPRS and GSM dual-mode communication modes are available with stable operation and reliable performance. Through the remote monitoring module, real-time online monitoring and remote fault diagnosis can be realized to provide customers with more value-added services.

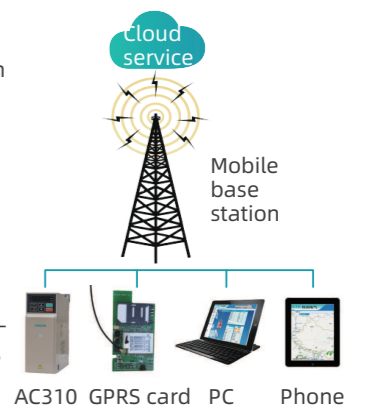

Communication expansion card



Communication expansion card model	Note
Modbus-RTU	Optional
PROFIBUS-DP	Optional
CANopen	Optional
PROFINET	Optional
.....	

Model Description

AC310-T3-037 G/45 P-B (L)

Series name
AC310

Voltage level

Codename	Definition	Codename	Definition
S	Single phase	2	220V
T	Three phase	3	380V
		6	660V

- Integrated accessories
B: Built-in braking unit
L: Built-in DC reactor
BL: Built-in braking unit and DC reactor
LD: Cabinet units with built-in DC reactors
- Drive type
G: Heavy load mode
P: Light load mode
- Power level
2R2: 2.2kW
004: 4kW
.....

Rated output current

Voltage	220V	380V	660V
	Rated output current (A)		
0.75	4	3	
1.5	7	4	
2.2	10	6	
4	16	10	
5.5	20	13	
7.5	30	17	
11	42	25	
15	55	32	
18.5	70	38	
22	80	45	28
30	110	60	35
37	130	75	45
45	160	90	52
55	200	110	63
75	260	150	86
90	320	180	98
110	380	210	121
132	420	250	150

Voltage	220V	380V	660V
	Rated output current (A)		
160	550	310	175
185	600	340	198
200	660	380	218
220	720	415	235
250		470	270
280		510	330
315		600	345
355		670	380
400		750	430
450		810	466
500		860	540
560		990	600
630		1200	690
710		1340	760
800		1500	860
900		1600	932
1000		1720	1080
1120		1980	1200

Installation Dimension Diagram

Plastic case model

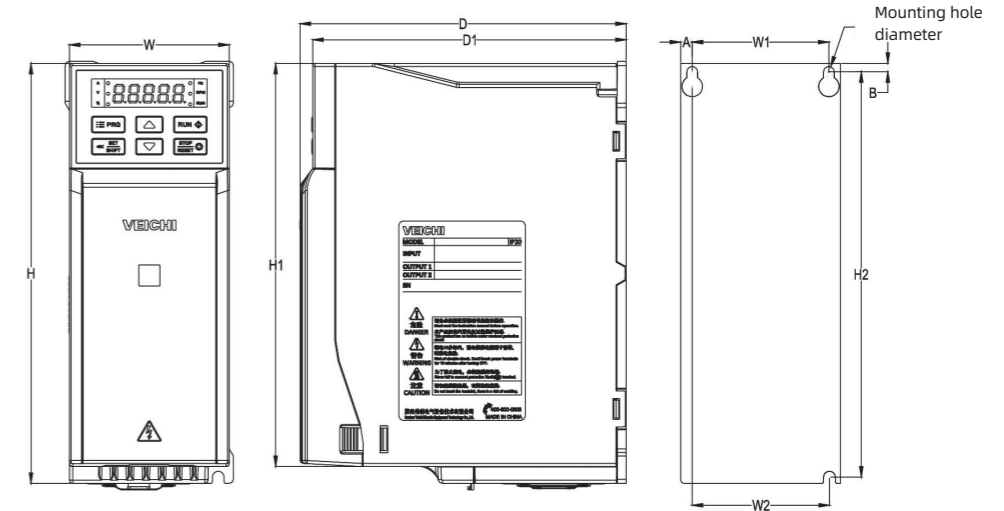

Model	Dimension (mm)					Installation size (mm)					Installation aperture
	W	H	H1	D	D1	W1	W2	H2	A	B	
AC310-T/S2-R75G-B	76	200	192	155	149	65	65	193	5.5	4	3-M4
AC310-T/S2-1R5G-B											
AC310-T/S2-2R2G-B	100	242	231	155	149	84	86.5	231.5	8	5.5	3-M4
AC310-T/S2-004G-B											
AC310-T/S2-5R5G-B	116	320	307.5	175	169	98	100	307.5	9	6	3-M5
AC310-T3-R75G/1R5P-B	76	200	192	155	149	65	65	193	5.5	4	3-M4
AC310-T3-1R5G/2R2P-B											
AC310-T3-2R2G-B	100	242	231	155	149	84	86.5	231.5	8	5.5	3-M4
AC310-T3-004G/5R5P-B											
AC310-T3-5R5G/7R5P-B	116	320	307.5	175	169	98	100	307.5	9	6	3-M5
AC310-T3-7R5G/011P-B	116	320	307.5	175	169	98	100	307.5	9	6	3-M5
AC310-T3-011G/015P-B											

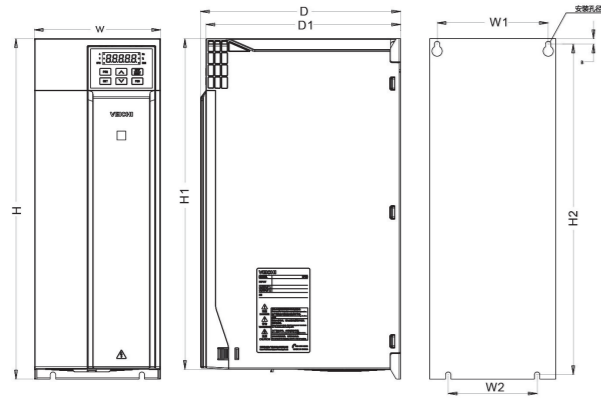

Model	Dimension (mm)					Installation size (mm)				Installation aperture
	W	H	H1	D	D1	W1	W2	H2	B	
AC310-T/S2-7R5G-B	142	383	372	225	219	125	100	372	6	4-M5
AC310-T/S2-011G-B										
AC310-T/S2-015G										
AC310-T2-018G	172	430	/	225	219	150	150	416.5	7.5	4-M5
AC310-T2-022G										
AC310-T3-015G/018P-B										
AC310-T3-018G/022P-B	142	383	372	225	219	125	100	372	6	4-M5
AC310-T3-022G/030P-B										
AC310-T3-030G/037P	172	430	/	225	219	150	150	416.5	7.5	4-M5
AC310-T3-037G/045P										

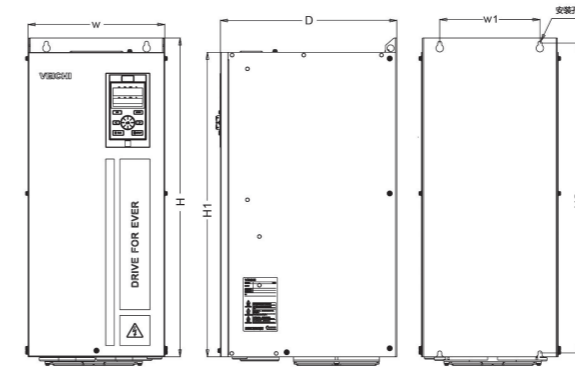

Model	Dimension (mm)				Installation size (mm)		Installation aperture
	W	H	H1	D	W1	H2	
AC310-T3-315G/355P-L							
AC310-T3-355G/400P-L	400	1250	1140	545	240	1213	4-M16
AC310-T3-400G/450P-L							
AC310-T3-450G/500P-L							
AC310-T3-500G/560P-L	460	1400	1293	545	300	1363	4-M16
AC310-T3-560G/630P-L							
AC310-T6-315G/355P-L							
AC310-T6-355G/400P-L	400	1250	1140	545	240	1213	4-M16
AC310-T6-400G/450P-L							
AC310-T6-450G/500P-L							
AC310-T6-500G/560P-L	460	1400	1293	545	300	1363	4-M16
AC310-T6-560G/630P-L							

Iron case model

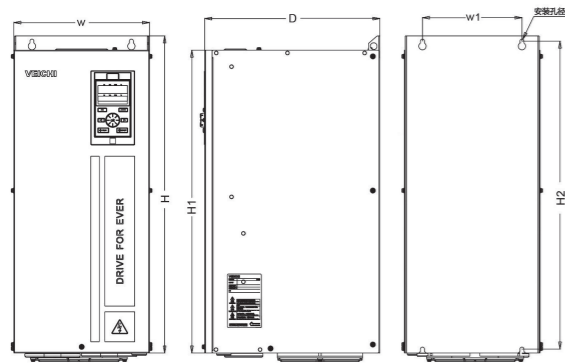

Model	Dimension (mm)				Installation size (mm)		Installation aperture
	W	H	H1	D	W1	H2	
AC310-T2-030G							
AC310-T2-037G	240	560	535	310	176	544	4-M6
AC310-T2-045G							
AC310-T2-055G	270	638	580	350	195	615	4-M8
AC310-T3-045G/055P							
AC310-T3-055G/075P	240	560	535	310	176	544	4-M6
AC310-T3-075G/090P							
AC310-T3-090G/110P	270	638	580	350	195	615	4-M8
AC310-T3-110G/132P							
AC310-T3-132G/160P-L	350	738	680	405	220	715	4-M8
AC310-T3-160G/185P-L							
AC310-T3-185G/200P-L							
AC310-T3-200G/220P-L	360	940	850	480	200	910	4-M16
AC310-T3-220G/250P-L							
AC310-T3-250G/280P-L							
AC310-T3-280G/315P-L	370	1140	1050	545	200	1110	4-M16
AC310-T6-022G/030P							
AC310-T6-030G/037P							
AC310-T6-037G/045P							
AC310-T6-045G/055P	240	560	535	310	176	544	4-M6
AC310-T6-055G/075P							
AC310-T6-075G/090P							
AC310-T6-090G/110P	270	638	580	350	195	615	4-M8
AC310-T6-110G/132P							
AC310-T6-132G/160P-L	350	738	680	405	220	715	4-M8
AC310-T6-160G/185P-L							
AC310-T6-185G/200P-L							
AC310-T6-200G/220P-L	360	940	850	480	200	910	4-M16
AC310-T6-220G/250P-L							
AC310-T6-250G/280P-L							
AC310-T6-280G/315P-L	370	1140	1050	545	200	1110	4-M16

Cabinet model

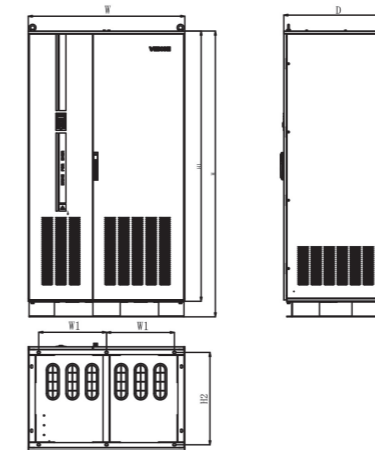

Model	Dimension (mm)				Installation size (mm)		Installation aperture
	W	H	H1	D	W1	H2	
AC310-T3-630G/710P-LD							
AC310-T3-710G/800P-LD							
AC310-T3-800G/900P-LD							
AC310-T3-900G/1000P-LD							
AC310-T3-1000G/1120P-LD							
AC310-T3-1120G-LD	1201	2198	2078	798	520	711	φ14
AC310-T6-630G/710P-LD							
AC310-T6-710G/800P-LD							
AC310-T6-800G/900P-LD							
AC310-T6-900G/1000P-LD							
AC310-T6-1000G/1120P-LD							
AC310-T6-1120G-LD							

Accessory List

AC300PG01

5V and 12V power PG cards available here support the incremental differential output encoder and the open collector output encoder.

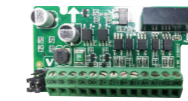

AC300IO1

Four digital inputs(X10 supports 50k pulse input), one digital output, one analog input and one relay output. Support temperature detection(PT100,PT1000 and KTY84)



AC300RT1

Support four different ratios of 0.219, 0.286,0.5,0.58,the factory default ratio is 0.5



KBD10-15

External LED five-digit display keyboard ,potentiometer speed control



AC300CAN1

CANopen expansion card



AC300PN card

Support standard profinet



AC300DP01

Profibus communication expansion card



KBD300-25

Dual line external five-digit display keyboard, silicone buttons, digital potentiometer



AC300-GPRS

Equipment positioning and maintenance, real-time monitoring, data collection



KBD300-L1 LCD keyboard

User-friendly LCD interface



Wiring Diagram

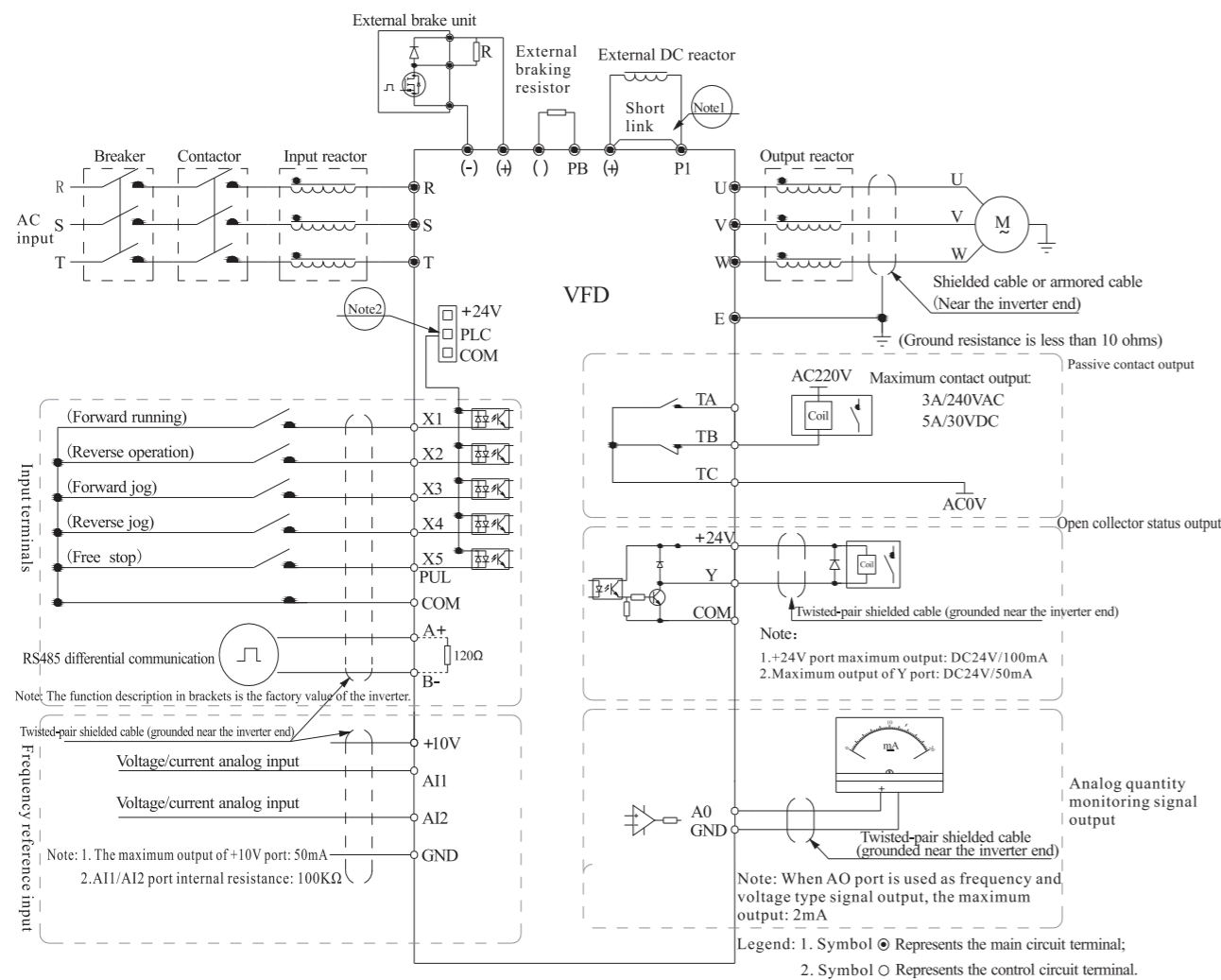

Note:1. When installing the DC reactor, be sure to remove P1 (+) shorting tab between terminals.
 2. Choose NPN or PNP transistor signal as input for multi-function input terminals (X1~ X5/PUL), and choose the drive internal power supply (+24V terminal), or the external power supply (PLC terminal) for bias voltage. The factory default "+24V" and "PLC" are shorted, and the position of the shorting tab is placed between RJ45 and the terminal.

Applications

Automated production line	Industrial mining	Machine tool	Municipal environmental protection
Lifting	Oilfield	Wires and cables	Woodworking machinery
Printing and packaging	Chemical industry	Industrial power	Plastics machinery
Textile	Elevator	Ceramics machinery	Food processing