

General Series HMI Installation Manual

Part 1 General Note

- The communication interfaces of this series of HMI all support RS232, RS485, RS422 communication, which are composite communication ports. When downloading the project, please use the USB download cable, U disk or Ethernet interface to download.
- The power ground must be connected to make the HMI run correctly.
- The communication ground must be connected to make the HMI communicate correctly.

Part 2 Safety Precautions

Notice following safety precautions at any moment when installing, wiring, operating, vindicating and examining.

Installation

- Please setup the HMI according to this manual otherwise it may cause device damage.
- It's forbidden to uncover the product in the environment that has water vapor, corrosive gas or combustible gas, otherwise it may cause short circuit or fire.

Wiring

- Please connect the grounding terminal with class-3ground, otherwise it may cause short circuit or fire.
- This series HMI use 24-volt power supply. Any connection of non-standard power supply will lead to machine damage.

Operation

- This series HMI need PISudio software to design project picture. HMI not designed may lead to run abnormally.
- Do not change wiring while the power is ON, otherwise it may cause short circuit or device damage.
- Please do not touch panel with sharp objects, otherwise it may lead to panel depressed, thereby make HMI run abnormality.

Maintenance

- It's forbidden to touch inside HMI, or else it may lead to short circuit or device damage.
- When power, it's forbidden to dismantle HMI panel, otherwise it may lead to short circuit or device damage.
- Do not touch connection terminal in 10 minutes of turning off power, otherwise residual voltage may lead to short circuit or device damage.
- When operating, exhaust vent should not be sealed, otherwise it may lead to failure easily.

Communication

- Please connect to the communication wire according to this manual.
- The length of communication wire should meet the requirement.
- Use the correct ground loops in order to avoid abnormal communication.

Part 3 Work Environment

The product must be placed in the pack box before installation, if not used for a while, in order to make the product accord with the warranty of our company and future maintenance, be sure to notice the following items when stored.

- Storage environment must be dry and dust-free.
- Storage ambient temperature must refer to "Specifications".
- Storage humidity must refer to "Specifications".
- Avoid corrosive gases and liquids in the storage environment.
- Avoid placing the product directly on the ground.

Part 4 Basic Inspection

Please do following basic checking before using this series HMI.

General

- Check if any screw is loose.
- The vent hole should be protected from oil, water and metal powder, and the chip powder of the drill should be prevented from falling into the HMI.
- If there are harmful gases or dust in the HMI operating environment, please take protective measures.

Checking before installation (Unpowered)

- Please deal with connection division of wiring terminal insulated.
- Communication wiring should be correct, otherwise abnormal operation may occur.
- Check for foreign matter entering the interior of the HMI, especially for flammable substances and conductive materials such as screws, metal sheets, etc.
- Please regulate instrument to reduce electromagnetism interference.
- Check HMI supply voltage.

Checking before running (powered)

- Check the status of the power indicator.
- Check if the communication between the HMI and the device is normal.
- If there is any abnormality in the HMI interface, please contact the manufacturer.

Part 5 Packing List

Sequence number	Component	Quantity
1	this series HMI	1
2	HMI fixed buckle	4
3	Power terminal	1

Part 6 Specifications

Module	PI3070 / PI3102 / PI3102H / PI3102HE	PI8070 / PI8070C / PI8070H / PI8102 / PI8102H / PI8104
Content		
Power voltage	DC24V	
Power voltage range	DC12V-DC28V	
Permissible instantaneous power failure time	<5ms	
Power consumption	<10W	
Operating ambient temperature	-10°C~+60°C	
Storage ambient temperature	-20°C~+70°C	
Operating ambient humidity	10%~90%RH (Non-condensing)	
Storage ambient humidity	10%~90%RH (Non-condensing)	
Vibration resistance	Conforms to IEC61131-2 standard: Continuous vibration:10Hz~57Hz 0.0755mm,57Hz~150Hz 9.8m/s ² Intermittent vibration:10Hz~57Hz 0.0035mm,57Hz~150Hz 4.9 m/s ² in each X, Y, Z direction 10 times (80 minutes)	
Corrosion resistance	Avoid corrosive gas	
Cooling method	Natural air cooling	

Part7 Parts and Function

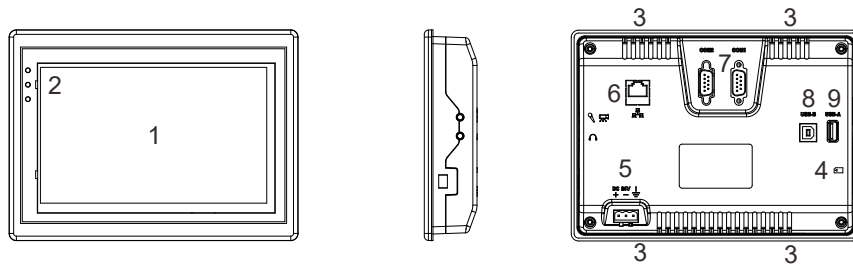

PI3070 Components description

1	LCD and touch screen	2	LED	3	Fixed buckle	4	SD card slot	5	Power terminal
6	Ethernet	7	COM port	8	USB-B	9	USB-A		

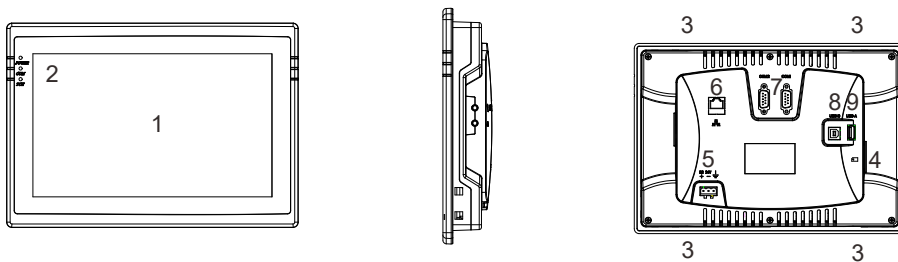

PI3102 / PI3102H Components description

1	LCD and touch screen	2	LED	3	Fixed buckle	4	SD card slot	5	Power terminal
6	Ethernet	7	COM port	8	USB-B	9	USB-A		

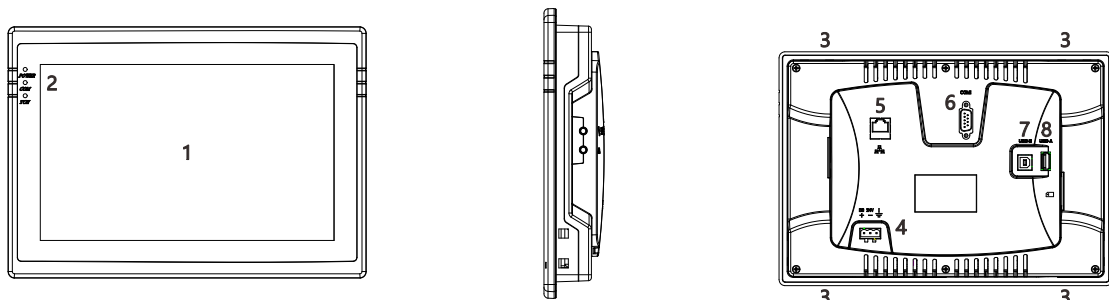

PI3102HE Components description

1	LCD and touch screen	2	LED	3	Fixed buckle	4	Power terminal	5	Ethernet
6	COM	7	USB-B	8	USB-A				

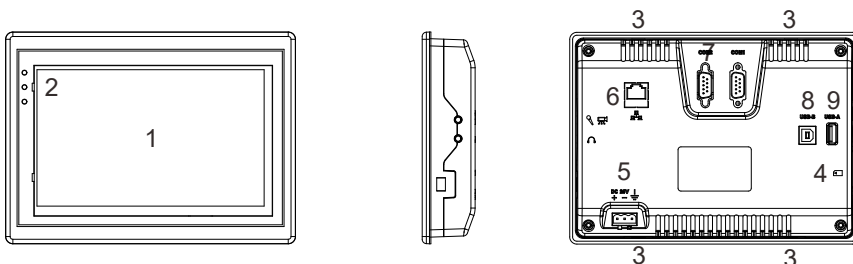

PI8070 / PI8070C / PI8070H Components description

1	LCD and touch screen	2	LED	3	Fixed buckle	4	SD card slot	5	Power terminal
6	Ethernet	7	COM port	8	USB-B	9	USB-A		

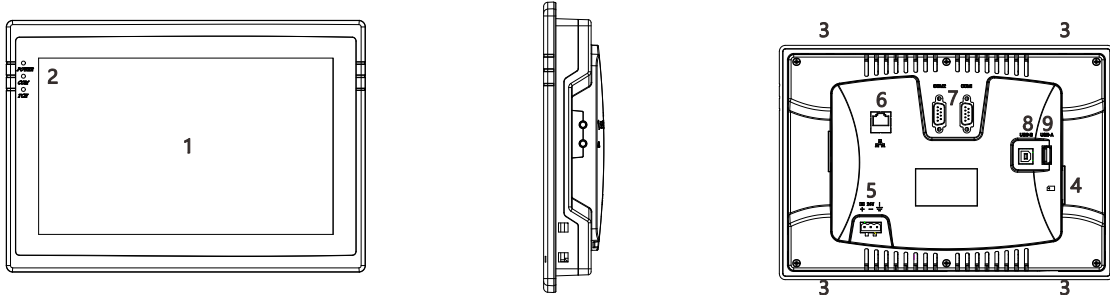

PI8102 / PI8102H Components description

1	LCD and touch screen	2	LED	3	Fixed buckle	4	SD card slot	5	Power terminal
6	Ethernet	7	COM port	8	USB-B	9	USB-A		

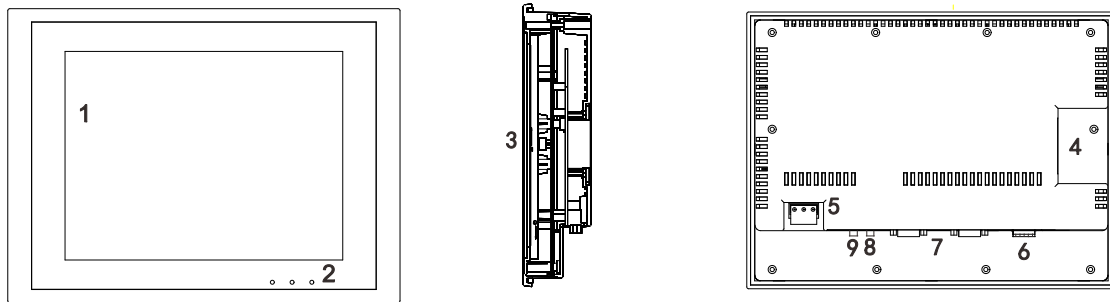

PI8104 Components description

1	LCD and touch screen	2	LED	3	Fixed buckle	4	SD card slot	5	Power terminal
6	Ethernet	7	COM port	8	USB-B	9	USB-A		

The power interface is defined as follows (from left to right):

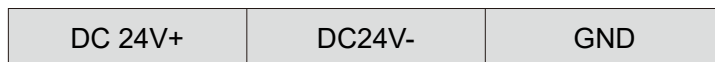
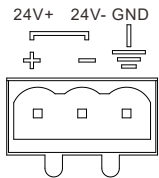

Part8 The Size of Product

Unit : mm , error range: ±0.5mm

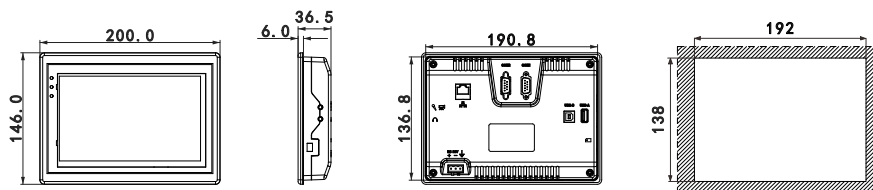

PI3070 installation size

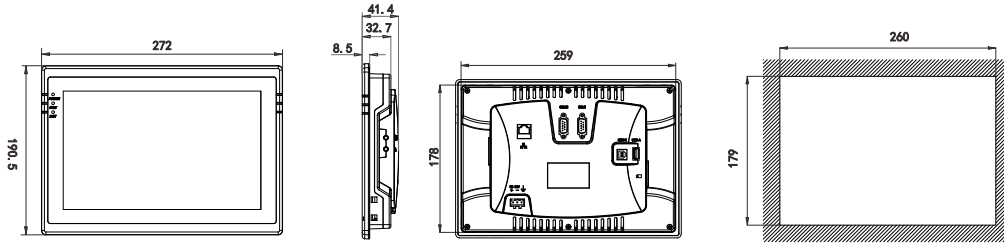

PI3102 / PI3102H installation size

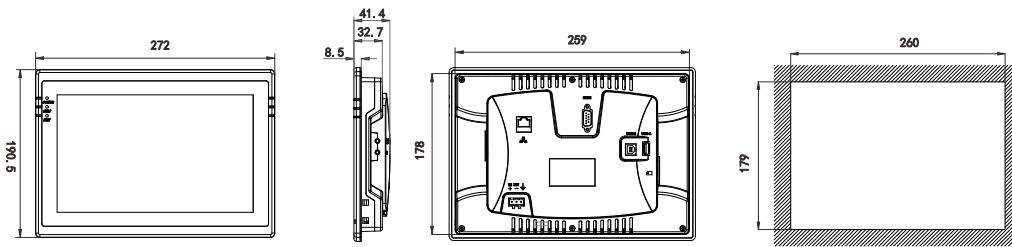

PI3102HE installation size

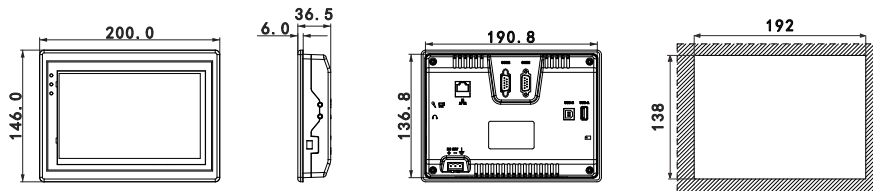

PI8070 / PI8070C / PI8070H installation size

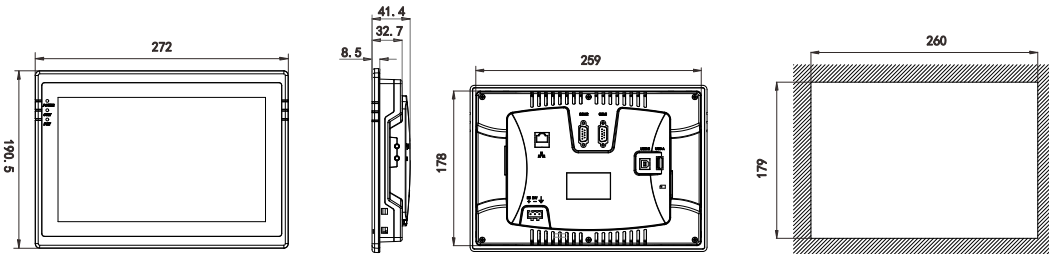

PI8102 / PI8102H installation size

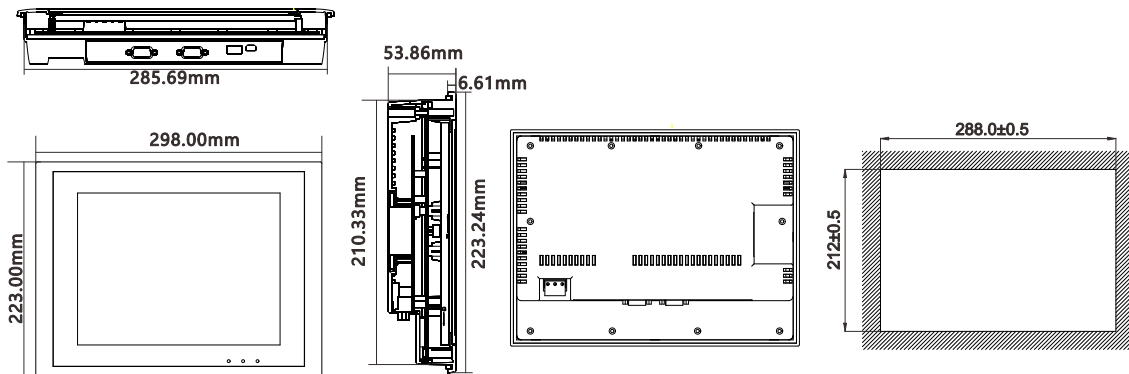

PI8104 installation size

Part 9 Touch Screen Calibration

After starting HMI, keep on pressing top left corner of screen about 3 to 5 seconds, an interface will appear as following:

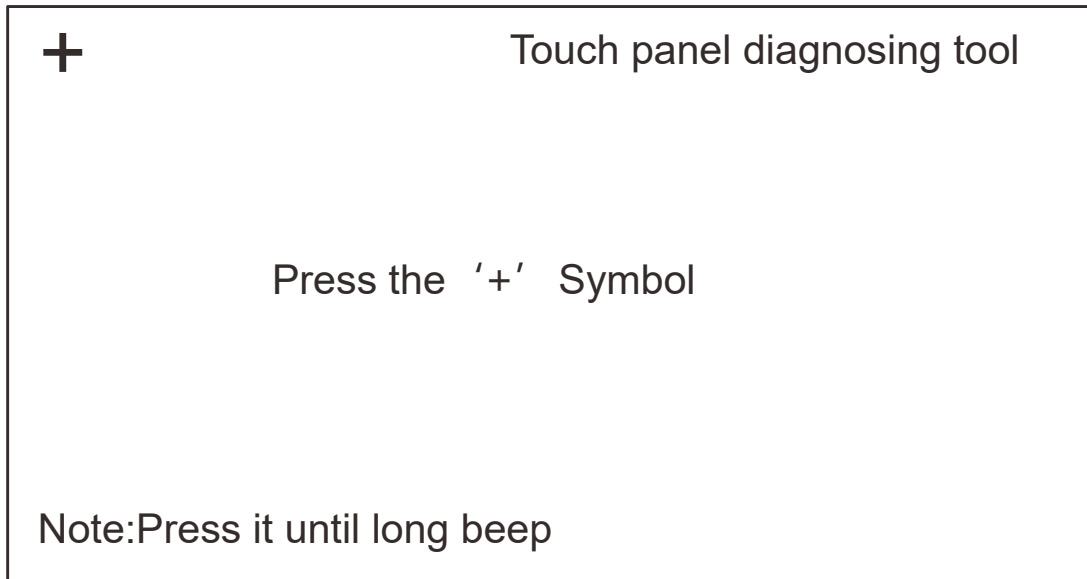

Click top left corner, top right corner, bottom right corner, bottom left corner and the center of '+' in turn and restart.

Part 10 Parameters Setting

Keep on pressing top right corner of screen about 3 to 5 seconds, an interface will appear as following:

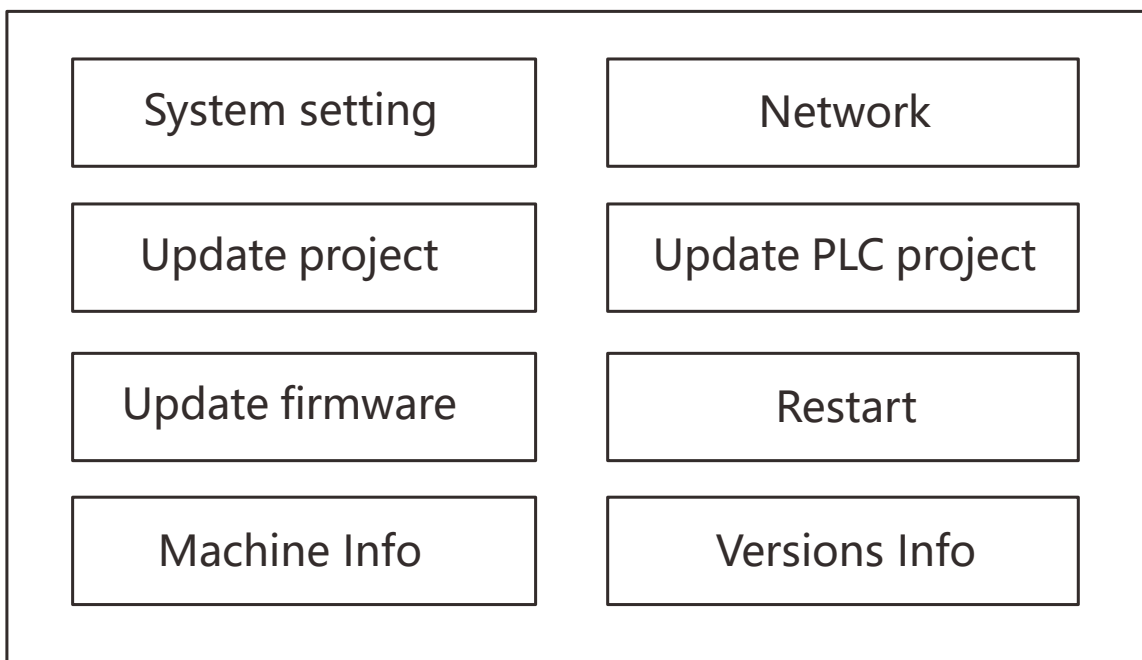

Part 11 Product Installation

Notes:

- The installation direction must be in accordance, otherwise it may lead to fault.
- In order to make circle effect greatly, adjacent objects and baffle should be kept on enough space when installation, otherwise it will cause bad cooling.
- Used in crust plane of Type 4X indoor grade.

Installation steps:

- Make sure the waterproof gasket is cased, and then install HMI to the adaptive crust.
- Make sure the fixed piece screw is cased, and then hitch front cover screw to withstand inside control box.
- Please tight screws aptly and remember not to exceed this torque, otherwise it will lead to crustaceous damage. Torque:6.17lb-inch (0.7N-M)

Part 12 Interface Definition

PI3070 / PI3102 / PI3102H series interfaces

COM1 definition:

Pin	Definition	Pin	Definition
1	RS422 TX+/RS485 A +	2	RS232 RXD
3	RS232 TXD	5	GND
6	RS422 TX-/RS485 B-	8	RS422 RX-
9	RS422 RX+		

COM2 definition:

Pin	Definition	Pin	Definition
1	RS485 A +	2	RS232 RXD
3	RS232 TXD	5	GND
6	RS485 B-		

▲ Note: The COM1 port of PI3070 / PI3102 / PI3102H series HMI can only support one communication mode at the same time.

PI3102HE series interfaces

COM1 definition:

Pin	Definition	Pin	Definition
1	RS422 TX+/RS485 A +	2	RS232 RXD
3	RS232 TXD	5	GND
6	RS422 TX-/RS485 B-	8	RS422 RX-
9	RS422 RX+		

▲ Note:RS422 and RS485 cannot be used in COM1 port of PI3102HE series HMI at the same time.

PI8070 / PI8070H / PI8070C / PI8102 / PI8102H / PI8104 series interfaces

COM1 definition:

Pin	Definition	Pin	Definition
1	RS422 TX +/RS485 A1 +	2	RS232 RXD
3	RS232 TXD	4	CANL
5	GND	6	RS422 TX-/RS485 B1-
7	CANH	8	RS422 RX-
9	RS422 RX+		

COM2 definition:

Pin	Definition	Pin	Definition
1	RS485 A +	2	RS232 RXD
3	RS232 TXD	5	GND
6	RS485 B-	7	COM3 RS485 A+
8	COM3 RS485 B-		

PI8070C COM2 definition:

Pin	Definition	Pin	Definition
1	RS485 A +	2	RS232 RXD
3	RS232 TXD	4	CANL
5	GND	6	RS485 B-
7	CANH		

▲ Note:RS422 and RS485 cannot be used in COM1 port of PI8070 / PI8070H / PI8070C / PI8102 / PI8102H / PI8104 series HMI at the same time.

Notice

The contents of this manual are subject to change without notice.



Wecon Technology Fu Zhou

Address: 10 Building, E area, Fuzhou
Software park, Fujian, P. R. China;
Tel: 0086-591-87868869;
Email: sales@we-con.com.cn;
Web: www.we-con.com.cn/en;

WECON_General_20230701