

# OPERATING INSTRUCTIONS

## Battery "Fuel" Gauge & Digital Maintenance Hour Meter

Please read and understand the following notices carefully, and correctly install and operate the product before using.

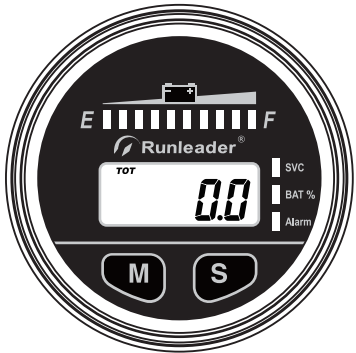

### Notice

- Please make sure to refer to the installation instructions in the operating instructions to avoid damage caused by installation errors.
- Failure to install and operate the unit in accordance with these instructions may result in damage or injury.
- Please install the product in a proper location to avoid the possibility of this product being hit and prevent damage to the product.
- Installation and start-up must be performed by skilled personnel.
- If instrument failure or malfunction may cause personal injury or material damage, use additional safety measures such as limit switches, guards, etc.
- This instrument was manufactured and tested according to the applicable technical standards. It complies with all the safety regulations as shipped from the factory.
- Please use the product at the specified temperature; high temperature environment may cause damage to the product.

### PRODUCT ACCESSORIES LIST

1 Product*1	2 User manual*1	3 Runleader color box*1
4 Connector plug*1	5 Connector spring*8	4 M4 Flange nut*2
		5 Mounting bracket*1

### PRODUCT INSTALLATION

#### 1. Mounting hole opening

The mounting panel is required matching installation groove and holes, if don't have, please install the groove and drill corresponding holes in the mounting panel.

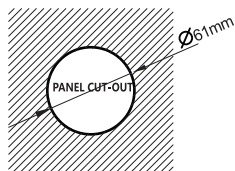

### 2. Product fixing

Insert the battery meter into the mounting panel as below picture, mounting the brackets pass through the screws and top side against the mounting plate, then secured by screw nuts.

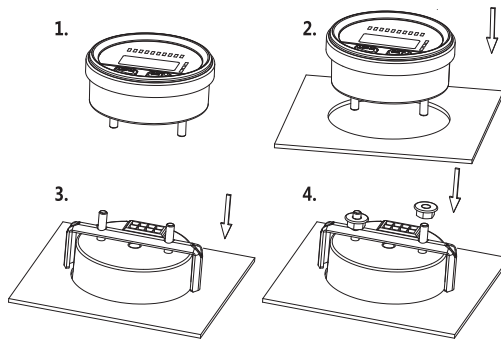

### WAY OF WIRING

#### 1. Description of the connection port

The pin function of the 8-hole connector is as follows:

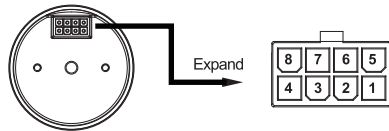

Pin NO.	Pin mark	Pin meaning	Description
1	B-	Input negative power supply	Connected to the negative pole of the battery
2	HRM+	High level timing terminal	With a high level trigger, the timer starts timing
3	Key Switch	Key switch	Connect the key switch to control the display and off of the LCD screen
4	B+	Input positive power supply	Connected to the positive pole of the battery
5	OUT 5V	Output terminal	Output 5V voltage
6	N/A	Standby	ODM custom pin function, (factory implementation)
7	N/A	Standby	ODM custom pin function, (factory implementation)
8	HRM-	Low level timing terminal	With a low level trigger, the timer starts timing

#### 2. Install connection port

##### Step1: B+ (pin 4) & B- (pin 1) installation

- The pin 4(B+) pin is connected to the positive pole of the battery, and the pin 1(B-) is connected to the negative pole of the battery.
- If only these two pins are connected, the LCD display will light, but the timing function will not work.
- Please make sure the battery voltage matches the voltage of the battery fuel gauge before connecting. Excessive voltage will damage the product.

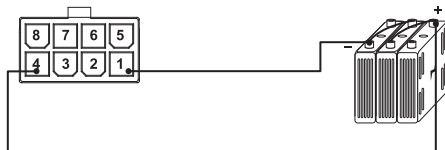

##### Step2: Key Switch (pin 3) installation

- Connect the key switch to control the battery indicator display to turn on or off.
- If the key switch is not used, connect the modified pin 3(Key Switch) to pin 4(B+), otherwise the corresponding function status indicator will not light.

#### A. Key Switch Connection

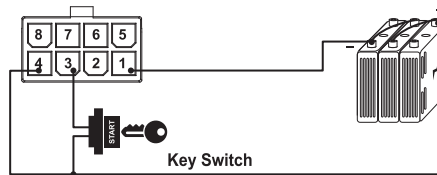

#### B. NO Key Switch, Direct Connection

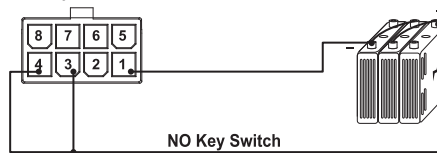

##### Step3: HRM+ (pin 2) or HRM- (pin 8) installation

- HRM+: More than 7V voltage signal to enable the timing function.
- HRM-: Low level signal (ground) to enable timing function.
- The timing function will not work when the HRM+ (pin 2) or HRM- (pin 8) is not connected.
- This function is used to record the running time of the parts you need to record. When the part is working, the time is recorded, and when it is not working, the time is stopped.
- You can also connect HRM+ (pin 2) to B+ (pin 4) to enable the timing function, or connect HRM- (pin 8) to B- (pin 1) to turn on the timing function;
- If the HRM+ (pin 2) or HRM- (pin 8) is not connected, the timing function will not work.

#### A. HRM+ enable timing

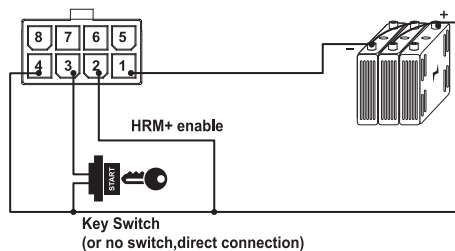

#### B. HRM- enable timing

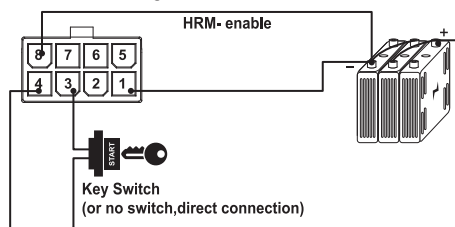

##### Step4: OUT 5V (pin 5) installation

- This function is used to control an external component in different states of battery power. When the battery power is more than 10%, it outputs 5V voltage; when the battery power is less than 10%, it outputs 0V voltage.
- When this function is not used, it will not affect other functions of the meter.

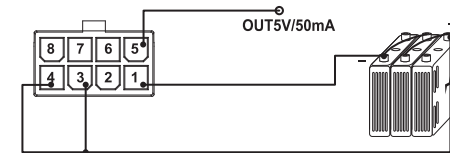

### PRODUCT USAGE

#### Battery power level indication area



#### Function indication area



#### 1. Function indication area

- There are 3 display interfaces in the function indication area; press the "M" button to select.
- After selection, the interface will remain and will not jump to other interfaces.

Figure 1

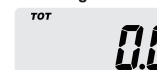

Figure 2



Figure 3



#### 2. TOT--- Total hours of operation

- Press the "M" button to select, so that the total time is always displayed on the screen.
- TOT time can not be reset.
- The TOT time max value is 99999; When the TOT timing range is 0.0-9999.9 hours, the timing accuracy is 0.1H; When the TOT timing exceeds 9999.9hours, the timing accuracy is 1H.
- When the TOT time exceeds 99999 hours, the timing will restart from 0.
- The "TOT" icon will flash when timing is in progress.

#### 3. Hour meter initial time setting

- You can program a start hours (old hour meter data) to replace an old hour meter.
- Hour meter initial time setting and operation need to be performed under display interface 1. (figure 1)

- Press the "M" button to get the display interface 1.
- Press the "S" button twice until display shows "h-SET" icon.
- Press and hold the "S" button until display shows "0000.0" icon start flashing, release and press "S" button to get the number you want, and the "M" button to select the value digit.
- Release the button and wait for 10 seconds and display will return to display interface 1. (The setting of the hour meter initial time is completed)

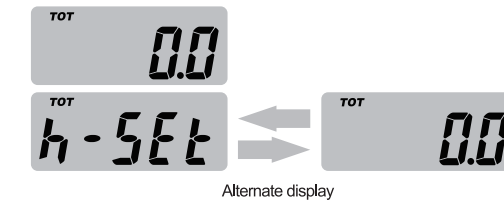

#### 4. SVC--- Maintenance interval time. Note: timing is countdown.

- After setting the maintenance interval time, the SVC status indicator will light green.
- When the SVC remaining time is less than 1 hours, the SVC status indication changes from green to yellow and remains flashing.
- When the SVC time is finished, the SVC status indicator changes from a yellow light to a red light and continues to flash for 2 hours.
- When the SVC time exceeds 2 hours, the SVC status indicates that the red light stops flashing and remains lit.
- Press the "S" or "M" button simultaneously to clear the status, the next maintenance interval time starts timing.

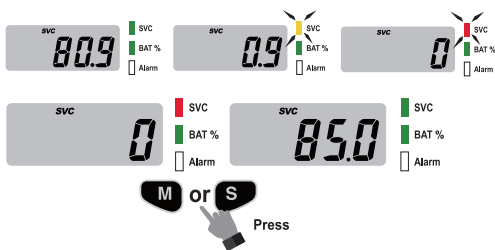

■ SVC setting and operation need to be performed under display interface 1. (figure 1)  
Programming SVC time:

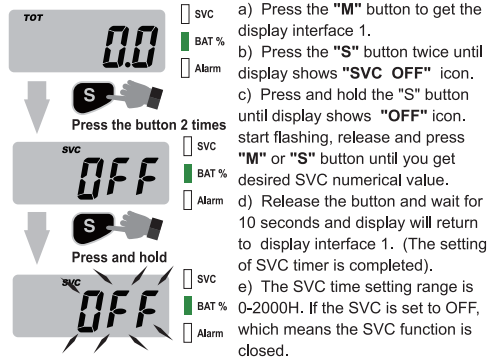

- Press the "M" button to get the display interface 1.
- Press the "S" button twice until display shows "SVC OFF" icon.
- Press and hold the "S" button until display shows "OFF" icon. start flashing, release and press "M" or "S" button until you get desired SVC numerical value.
- Release the button and wait for 10 seconds and display will return to display interface 1. (The setting of SVC timer is completed).
- The SVC time setting range is 0-2000H. If the SVC is set to OFF, which means the SVC function is closed.

## 5. Backlight Choice

■ Backlight setting and operation need to be performed under display interface 1. (figure 1)

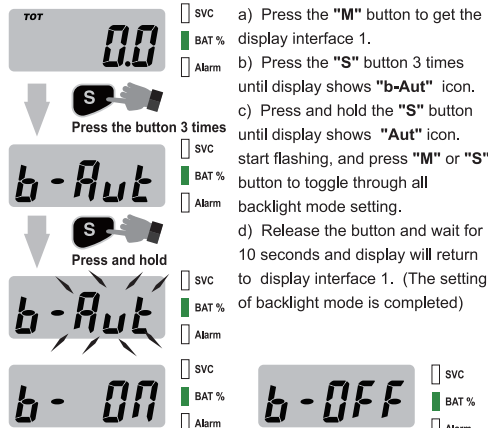

- Press the "M" button to get the display interface 1.
- Press the "S" button 3 times until display shows "b-Aut" icon.
- Press and hold the "S" button until display shows "Aut" icon. start flashing, and press "M" or "S" button to toggle through all backlight mode setting.
- Release the button and wait for 10 seconds and display will return to display interface 1. (The setting of backlight mode is completed)

b-Aut	the backlight will be automatically turned off, when press the button, the backlight will be on.
b-ON	the backlight is always on, when key switch turning on.
b-OFF	turn off the backlight display.

## 6. Setting Battery "Fuel" Gauge

Step1: Select the applicable battery voltage

■ Select the applicable battery voltage need to be performed under display interface 2. (figure 2)

- Press the "M" button once to get the display interface 2.
- Press the "S" button once until display shows "U-12" icon.
- Press and hold the "S" button until display shows "12" icon start flashing, and press "M" or "S" button to toggle through all battery voltage mode setting.
- Release the button and wait for 10 seconds and display will return to display interface 2. ( Select the applicable battery voltage is completed)

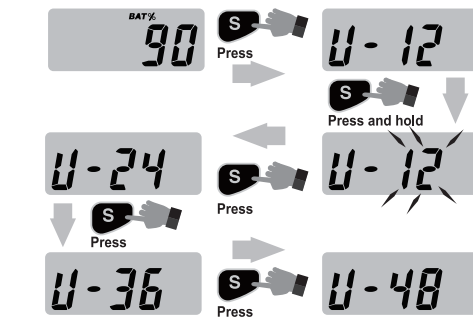

■ The meaning of U-12 means: for your 12V battery ; This gauge is suitable for different batteries of 12V 24V 36V 48V; When using, please follow the above operation to configure the appropriate voltage unit.

Step2: Choose the battery discharge type

- Different types of batteries at the same voltage will have different discharge curves.
- Choosing the right type of discharge curve can help you more accurately indicate battery usage.
- This gauge provides 9 types discharge curves for you to choose from.

Type	Cell empty	Cell full	Voltage Range	Applicable battery type
bt-1	1.73v	2.05v	U-12 10.38v~12.30v	Suitable for measuring common types lead-acid batteries from 12V to 48V
			U-24 20.76v~24.60v	
			U-36 31.14v~36.90v	
			U-48 41.52v~49.20v	
bt-2	1.9v	2.1v	U-12 11.40v~12.60v	Suitable for measuring common types GEL batteries from 12V to 48V
			U-24 22.80v~25.20v	
			U-36 34.20v~37.80v	
			U-48 45.60v~50.40v	
bt-3	2.75v	3.4v	U-12 11.00v~13.60v	Suitable for measuring common types Lithium iron phosphate batteries (LiFePO4) from 12V to 48V
			U-24 22.00v~27.20v	
			U-36 33.00v~40.80v	
			U-48 44.00v~54.40v	
bt-4	1.92v	2.1v	U-12 11.51v~12.62v	Suitable for measuring 12V to 48V American brand "Trojan" new batteries; Usually EZGO's club car has a battery with similar performance.
			U-24 23.02v~25.24v	
			U-36 34.53v~37.86v	
			U-48 46.04v~50.48v	
bt-5	1.75v	2.08v	U-12 10.50v~12.50v	Suitable for measuring common types AGM batteries from 12V to 48V
			U-24 21.00v~25.00v	
			U-36 31.50v~37.50v	
			U-48 42.00v~50.00v	
bt-6	3.2v	4.05v	U-12 12.80v~16.20v	Suitable for measuring common types 18650 lithium batteries from 12V to 48V
			U-24 22.40v~28.35v	
			U-36 32.00v~40.50v	
			U-48 41.60v~52.65v	
bt-7	1.82v	2.08v	U-12 10.92v~12.48v	Suitable for measuring other types lead-acid batteries from 12V to 48V
			U-24 21.84v~24.96v	
			U-36 32.76v~37.44v	
			U-48 43.68v~49.92v	
bt-8	1.86v	2.05v	U-12 11.16v~12.30v	Suitable for measuring other types lead-acid batteries from 12V to 48V
			U-24 22.32v~24.60v	
			U-36 33.48v~36.90v	
			U-48 44.64v~49.20v	
bt-9	1.65v	2.0v	U-12 9.90v~12.00v	Suitable for measuring other types lead-acid batteries from 12V to 48V
			U-24 19.80v~24.00v	
			U-36 29.70v~36.00v	
			U-48 39.60v~48.00v	

■ This table uses a 12V battery. The voltage range of 24V 36V 48V is multiplied by 2 or 3 or 4 at a voltage of 12V.

■ When U-24 or U-36 or U-48 is selected, the measured voltage value will change automatically.

Choose the battery discharge type:

Choose the battery discharge type need to be performed under display interface 2. (figure 2)

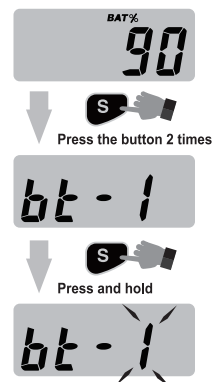

- Press the "M" button once to get the display interface 2.
- Press the "S" button twice until display shows "bt-1" icon.
- Press and hold the "S" button until display shows "1" icon start flashing, and press "M" or "S" button to toggle through all battery discharge type setting.
- Release the button and wait for 10 seconds and display will return to display interface 2. ( Choose the battery discharge type is completed)

- When the Step2 setting is completed, the BAT% indicator light will be illuminated correctly.
- When the battery power is more than 30%, the BAT% indicator light will show green.
- When the battery power is less than 30%, the BAT% indicator light will show yellow and keep flashing.
- When the battery power is less than 10%, the BAT% indicator light will show red and keep flashing.

Step3: Set the warning voltage value

- This function is used to measure the real-time voltage value of the user's battery; and an alarm warning for the voltage is designed.
- The warning voltage contains high voltage warning and low voltage warning.
- After setting the warning voltage value, the Alarm indicator light will light up and display green; when the warning value is reached, the Alarm indicator light will turn red and flash to remind.
- If the warning voltage value is not set, the Alarm indicator light will not light up.
- Set the warning voltage value need to be performed under display interface 3. (figure 3)

High & Low voltage warning setting

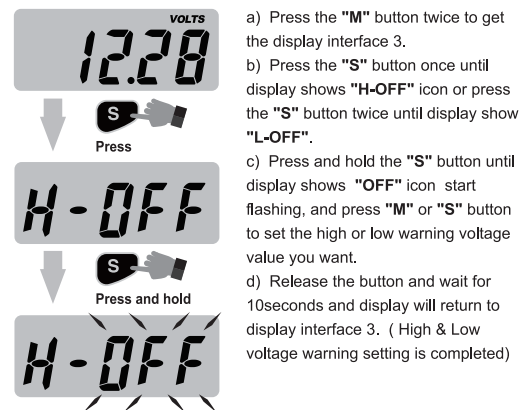

- Press the "M" button twice to get the display interface 3.
- Press the "S" button once until display shows "H-OFF" icon or press the "S" button twice until display show "L-OFF".
- Press and hold the "S" button until display shows "OFF" icon start flashing, and press "M" or "S" button to set the high or low warning voltage value you want.
- Release the button and wait for 10seconds and display will return to display interface 3. ( High & Low voltage warning setting is completed)

Step4: Use of the battery status indicator

Battery power level indication area.

- A display bar consisting of 10 red LED lights is used to indicate the battery status.
- When the battery is full, all 10 LED lights are on. As the battery power decreases, the LED lights go out one by one.
- When the remaining battery power is less than 10%, the first red indicator light flashes.
- When charging the battery, the LED lights will cycle and illuminate one by one.



To shut down the gauge

- Press the "M" and the "S" button at the same time until the "P-OFF" icon displayed on the LCD screen, then release the button and the gauge will shut down automatically.
- Press the "M" or "S" button to turn on the gauge.
- When the gauge screen is turned off, the historical data will be retained and will not be cleared.



## PRODUCT SPECIFICATIONS&PARAMETERS

	Model	RL-BI025
Timing range		0-99999H
Timing accuracy		0.1 H/1 H
SVC range		0-2000H
Battery indicator light		10 pcs
Accuracy of battery indicator		10%
Percentage accuracy of electric quantity		1%
Voltage display precision		0.01V
The battery apply		12V 24V 36V 48V
Applicable battery types		Lead-acid, GEL, LIFE-PO4, AGM
Number of battery curves		9
Backlit model		White、On/Auto/Off
Initial time setting		Yes (within 1 hour)
Waterproof rate		IP65
Product dimension		Φ62.5x41mm
Display window size		29x11mm
Panel CUT-OUT		Φ61mm
Housing material		ABS
Product net weight		52g

## PRODUCT DIMENSION

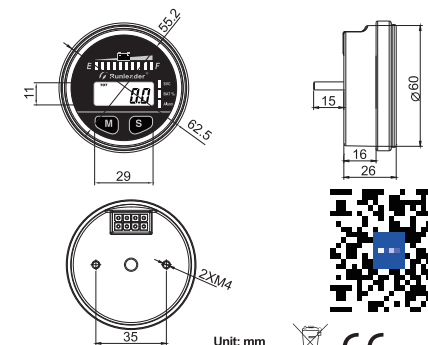

Unit: mm

